

## 2021-2022 PRODUCT CATALOGUE

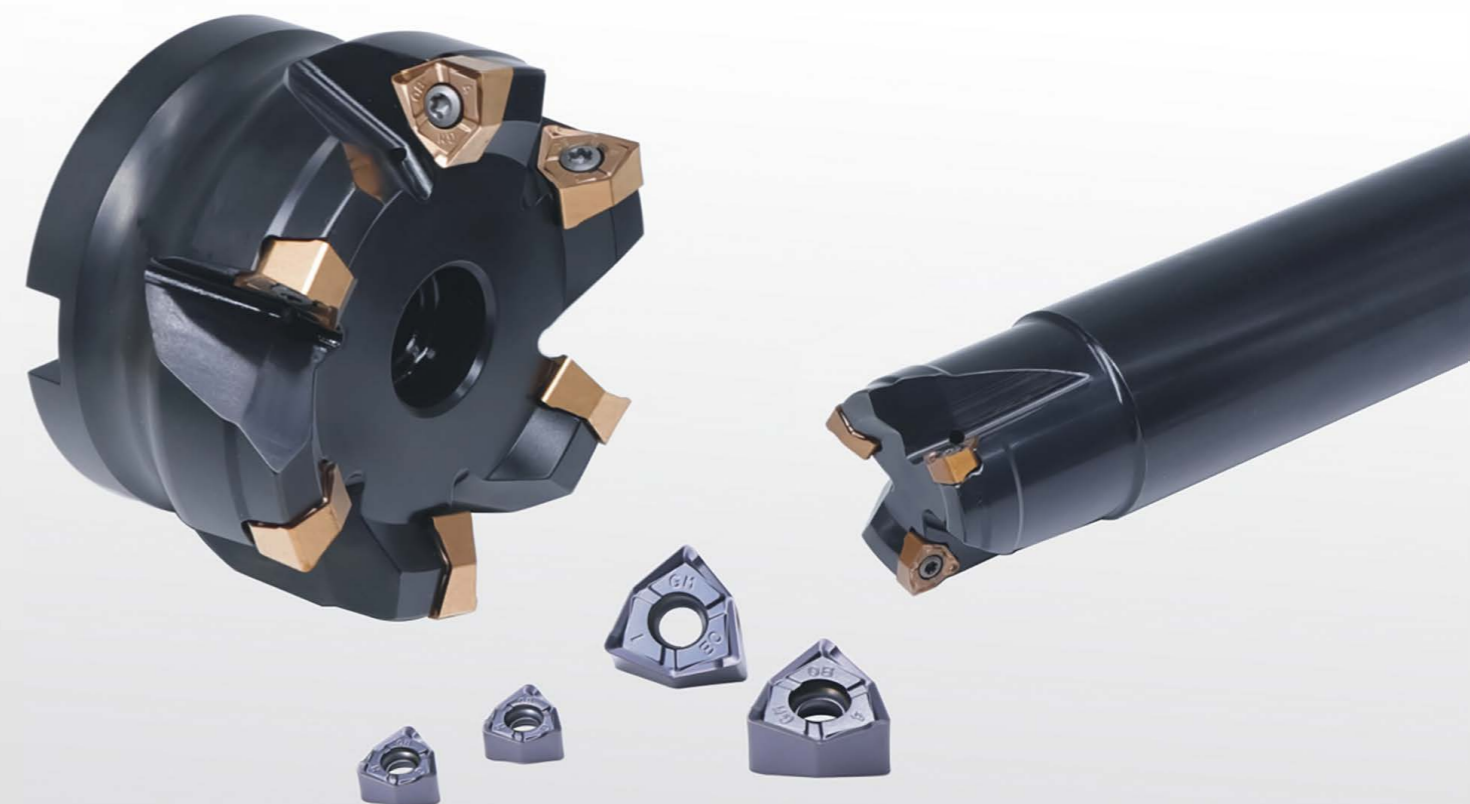



## COMPANY PROFILE

Zhuzhou Huarui Precision Cutting tools Co., Ltd. (Stock Code: 688059) was established in March 2007 with a registered capital of 44, 008, 000 CNY. As an advanced cutting tool manufacturer in China, HUARUI upholding the development strategy of "Independent Research & Development, Continuous Innovation", focus on the R&D, manufacture, sales and application of cemented carbide CNC cutting insert, constantly pursuing the improvement in overall performance and optimization in fabrication technology.

Relying on the multi-year technological accumulation and skilled talents, together with the intergration, assimilation and absorbtion of advanced equipment, HUARUI has formed their own independent core technology in the fields of "Substrate material", "Chip-breaker geometry", "Precision forming" and "Surface coating", and developed "Turning series", "Milling series" and "Drilling series" as the three major product range.

HUARUI is proud of their core product being the domestic leading level for their efficiency, long service life and cutting accuracy, successfully entered the high end markets which long time dominated by Europe, USA, Japan and Korea companies, Especially the milling series, it has formed a significant competitive advantage.

HUARUI has been awarded as the "National High-tech Enterprise", "National Small Giant Enterprise", "Hunan Province Recognized Enterprise Technology Center" and "100 Major Scientific and Technological Innovation Project 2020 Implementation Plan enterprise". Their "HARDSTONE" brand has been selected as the "Customer Satisfaction Brand" in the 4th Cutting Tool User Survey. And the independently developed FM series milling inserts has been awarded the "Golden Edge Awards" and "Ringier Technology Innovation Awards".

## HONOR



## TECHNOLOGY

HUARUI has a full set of process equipments and complete production line for CNC cutting insert manufacturing from powder material preparation, mould making, compression forming, pressure sintering, grinding, coating, post coating treatment to automatic packing. At the meantime, HUARUI adopt the R&D strategy of "Concentrate advantages to breakthrough each single product", focusing on the research and innovation of cemented carbide CNC cutting insert at the areas of substrate materials, chip breaker geometry, precision mould machining and surface coating, continuously improve the machining accuracy, efficiency and extend the service life. After more than ten years scientific research innovation, HUARUI has mastered lots of independent core technologies, possess strong independent R&D and design capabilities, and the overall technical strength has achieved the national advanced level.

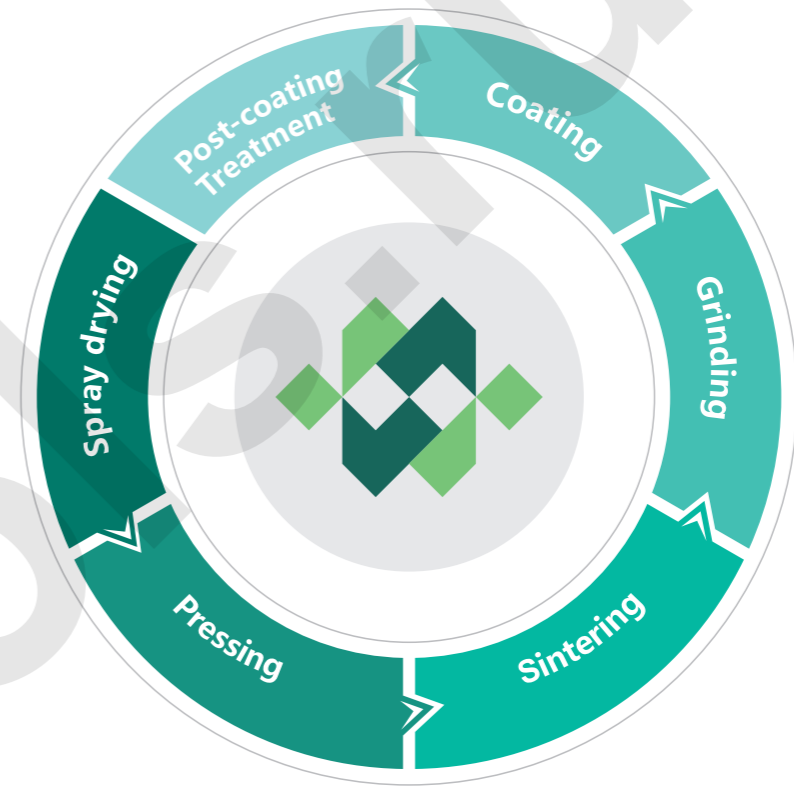

# CATALOGUE

## A Turning

- ◆ The introduction of grade..... A1-01-04
- ◆ Insert identification system..... A1-05-06
- ◆ Overview..... A1-07-08
- ◆ New grade..... A1-09
- ◆ The introduction of chip-breaker..... A1-10-13
- ◆ Negative insert..... A1-14-23
- ◆ Positive insert..... A1-24-26
- ◆ Cases..... A1-27-35

## C Threading

- ◆ Threading insert..... C3-01-03

## B Parting and grooving

- ◆ Grooving insert..... B2-01
- ◆ Cases..... B2-02-03

## D Drilling

- ◆ Drilling insert..... D4-01

## E Milling

- ◆ The introduction of grade..... E5-01-02
- ◆ Insert identification system..... E5-03-04
- ◆ Overview..... E5-05
- ◆ AOKT series..... E5-06-09
- ◆ Milling tool..... E5-10-12
- ◆ Square shoulder milling insert..... E5-13
- ◆ Profile milling insert..... E5-14
- ◆ Helical milling insert..... E5-14
- ◆ Face milling insert..... E5-15
- ◆ Economical square milling..... E5-15
- ◆ Milling tool..... E5-16-23
- ◆ Cases..... E5-24-28



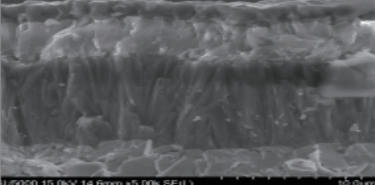
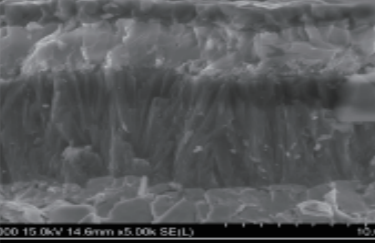
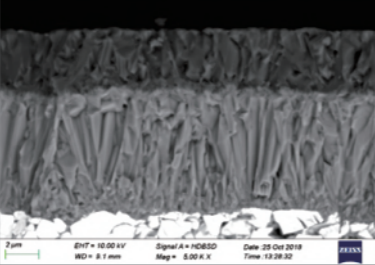
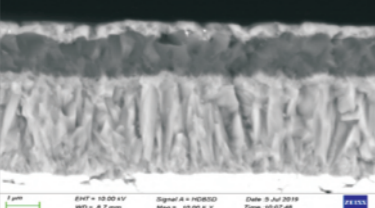
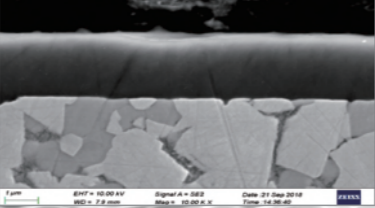
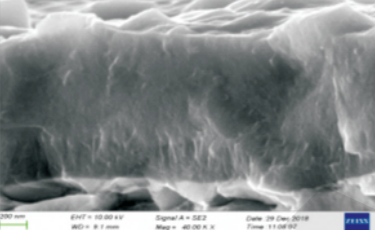

The introduction of grade

Grade	Coating				Characteristics	Application	ISO	Wear Resistance ← Toughness												
	Type	Color	Metallographic Structure	Composition				01	05	10	15	20	25	30	35	40	45			
WS8215	CVD	Double color black-yellow		TiN+MT -TiCN+Al <sub>2</sub> O <sub>3</sub> +TiN	The proprietary substrate of gradient alloy structure formed by special sintering process, together with thick TiCN, thick Al <sub>2</sub> O <sub>3</sub> , and sophisticated coating post treatment, not only makes the coating more beautiful, but also greatly improves the wear resistance. It is very suitable for finishing and semi-finishing of carbon steel and alloy steel.	Suitable for stable turning environment pursuit high wear resistance. For ordinary steel processing with good cooling, the linear velocity can be over 350m/min	P10-P20													
WS8135	CVD	Double color black-yellow		TiN+MT -TiCN+Al <sub>2</sub> O <sub>3</sub> +TiN	It has adopted the strengthen binder phase which can effectively inhibit the high temperature plastic deformation of the substrate; The fabrication of high binder phase content functional gradient layer effectively controlled the crack propagation of the coating; Uniform distributed hard phase particles considered both the toughness and wear resistance of the substrate; Coupled with the thickened and advanced CVD coating, it can widely used in various types of steel processing.	It is a most commonly used grade for steel turning, with superior performance for high speed interrupted semi-finishing and finishing.	P15-P35													
WS8133	CVD	Double color black-yellow		TiN+MT -TiCN+Al <sub>2</sub> O <sub>3</sub> +TiN	It has adopted the strengthen binder phase which can effectively inhibit the high temperature plastic deformation of the substrate; The fabrication of high binder phase content functional gradient layer effectively controlled the crack propagation of the coating; Uniform distributed hard phase particles considered both the toughness and wear resistance of the substrate; The medium thick TiCN coupled with thin alumina coat, provide superior performance for parting and grooving process of steel material.	It is an upgraded grade with better stability, design for high speed parting off and grooving of general-purpose steel parts.	P15-P35													
WS7120	CVD	Yellow		TiN+MT -TiCN+Al <sub>2</sub> O <sub>3</sub> +TiN	It has adopted the substrate with better high temperature hardness which provide good plastic deformation resistance under high speed cutting process; The compound multi-layer coating effectively blocked the longitudinal expansion of the coating cracks during the cutting process; Coupled with the fine coating post-treatment technology, provide a much more better, delicate and smooth coating surface. Suitable for roughing and semi-finishing of various types of stainless steel.	It is suitable for high speed and high efficiency roughing of stainless steel.	M15-M30													
WS7125	PVD	Grey-black		AlTiN	The precise and unique coating formulations, together with innovative high-performance coating processes, provide a delicate, smooth and dropletless coating, which has the advantages of low coefficient of friction, high antioxidant temperature, high nano hardness, etc. This coating can match different edge requirements to ensure optimum comprehensive performance for various chip breaker design.	Preferred grade parting and grooving of stainless steel. It can also meet the requirements of medium and low speed parting and grooving of steel and cast iron.	P15-P30 M15-M30 K15-K30													
WS7225	PVD	Brass-yellow		TiAlSiN	The precise and unique coating formulation with Si+ elements added, together with innovative high-performance coating processes, provide a delicate, smooth and dropletless coating, which has the advantages of low coefficient of friction, high antioxidant temperature, high nano hardness, etc. This coating can match different cutting edge requirements to ensure optimum comprehensive performance for various chip breaker design.	It is a commonly used upgraded grade for stainless steel turning, greatly improved the sticking resistance and wear resistance, it is also suitable for general speed semi-finishing and finishing of mild steel.	M15-M30													

- A
- Turning
- Grooving
- Threading
- Drilling
- Milling

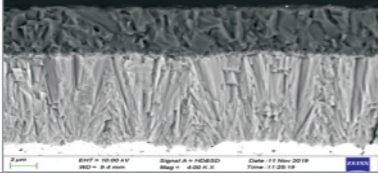
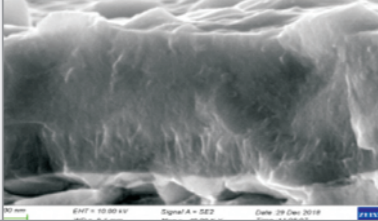
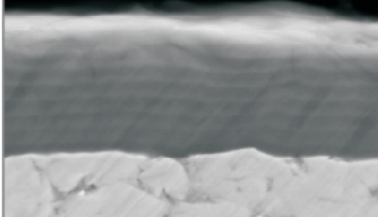
The introduction of grade

Grade	Coating				Characteristics	Application	ISO	Wear Resistance ← Toughness																
	Type	Color	Metallographic Structure	Composition				01	05	10	15	20	25	30	35	40	45							
WS6115	CVD	Black		TiN+MT -TiCN+Al <sub>2</sub> O <sub>3</sub>	The thickened CVD black diamond coating with special coating post-treatment, provide excellent wear resistance and toughness. Combined with the corresponding substrate, it has better universality and widely used in all kinds of cast iron machining.	It is a preferred grade for the turning of gray iron and ductile cast iron, with excellent comprehensive performance, it is also suitable for general interrupted machining, It can be used for low speed roughing of quenched steel and high strength steel.	K10-K20																	
WS5225	PVD	bronze		TiAlSiN	The special proportion of ingredients, with rare metals added, actively improves bending strength and heat-cack resistance of the substrate, together with the highest level cutting nose and cutting edge treatment technology, and the latest nano coating containing Si+ elements, greatly ensured the cutting insert with high hardness, wear resistance and sharpness.	It is an exclusive grade for threading of various materials.	P10-P25 M10-M25 K10-K25																	
WS5231	PVD	purple bronze		AlCrN+ TiSiN	The ultra-fine grainsize substrate material and special ingredient ratio actively improves the bending strength and wear resistance of the substrate, greatly reduced the crack risk of cutting edge. The PVD nano composite multi-layer coating effectively prevent the formation of longitudinal cracks. and the meantime, the small friction coefficient coating surface provide strong sticking resistance.	It is an exclusive grade for the drill machining of various materials.	P20-P35 M20-M35 K20-K35																	
WSK10	Un-coated	Silver grey		(K10)	Uniform and fine grain substrate material present high bending strength and good wear resistance; The fine treatment of cutting nose and cutting edge greatly ensured the sharpness and provide stable comprehensive performance.	It is used for turning, milling of graphite, cast iron and other non-ferrous metal materials like aluminum, copper, etc. It can also used for low speed turning of titanium alloy and high temperature alloy.	K05-K10																	

**A**

Turning

Grooving

Threading

Drilling

Milling

## Insert identification system

Insert Shape			Chip-breaker and Clamping system							
			<b>B</b>	With	Without		<b>N</b>	Without	Without	
			<b>H</b>	With	Single-Side		<b>R</b>	Without	Single-Side	
			<b>C</b>	With	Without		<b>F</b>	Without	Double-Side	
			<b>J</b>	With	Double-side		<b>A</b>	With	Without	
			<b>W</b>	With	Without		<b>M</b>	With	Single-Side	
		<b>Z</b>	<b>T</b>	With	Single-Side		<b>G</b>	With	Double-Side	
		<b>Z</b>	<b>Q</b>	With	Without		<b>X</b>	---	---	
		<b>Z</b>	<b>U</b>	With	Double-side					
<b>Insert Shape</b>			<b>Code</b>	<b>Hole</b>	<b>Chip-breaker</b>	<b>Section Plane</b>	<b>Code</b>	<b>Hole</b>	<b>Chip-breaker</b>	<b>Section Plane</b>

**C N M G**

### Clearance angle of main cutting edge

Code	Clearance angle	Code	Clearance angle
<b>A</b>		<b>B</b>	
<b>C</b>		<b>D</b>	
<b>E</b>		<b>F</b>	
<b>G</b>		<b>N</b>	
<b>P</b>		<b>O</b>	Others

Tolerance (mm)										
Code	Nose height Tolerance(m)	Inscribed circle(ΦD)	Thickness Tolerance(s)	◆ M-level tolerance(Identified by shape)						
				◆ Tolerance of tool tip height (mm)						
Code	Nose height Tolerance(m)	Inscribed circle(ΦD)	Thickness Tolerance(s)	Inscribed circle	Regular triangle	Square	Rhombus with 80°	Rhombus with 55°	Rhombus with 35°	Round
<b>A</b>	±0.005	±0.025	±0.025	6.35	±0.08	±0.08	±0.08	±0.11	±0.16	---
<b>F</b>	±0.005	±0.013	±0.025	9.525	±0.08	±0.08	±0.08	±0.11	±0.16	---
<b>C</b>	±0.013	±0.025	±0.025	12.7	±0.13	±0.13	±0.13	±0.15	---	---
<b>H</b>	±0.013	±0.013	±0.025	15.875	±0.15	±0.15	±0.15	±0.18	---	---
<b>E</b>	±0.025	±0.025	±0.025	19.05	±0.15	±0.15	±0.15	±0.18	---	---
<b>G</b>	±0.025	±0.025	±0.13	25.4	---	±0.18	---	---	---	---
<b>J</b>	±0.005	±0.05±0.13	±0.025	◆ Inscribed circle(ΦD)Tolerance						
<b>K</b>	±0.013	±0.05±0.13	±0.025	Inscribed circle	Regular triangle	Square	Rhombus with 80°	Rhombus with 55°	Rhombus with 35°	Round
<b>L</b>	±0.025	±0.05±0.13	±0.025	6.35	±0.05	±0.05	±0.05	±0.05	±0.05	---
<b>M</b>	±0.08±0.18	±0.05±0.13	±0.13	9.525	±0.05	±0.05	±0.05	±0.05	±0.05	±0.05
<b>N</b>	±0.08±0.18	±0.05±0.13	±0.025	12.7	±0.08	±0.08	±0.08	±0.08	---	±0.08
<b>U</b>	±0.13±0.38	±0.08±0.25	±0.13	15.875	±0.10	±0.10	±0.10	±0.10	---	±0.10
				19.05	±0.10	±0.10	±0.10	±0.10	---	±0.10
				25.4	---	±0.13	---	---	---	±0.13

Diameter of IC(mm)	Insert shape								Insert Thickness	
									Code	Thickness(mm)
32.00									12	12.70
31.75									10	11.11
25.40									T9	9.72
25.00	25	25							09	9.52
20.00									07	7.94
19.05	19							33	T6	6.75
16.00		19							06	6.35
15.875	16								T5	5.95
12.70	12	15							05	5.56
12.00									T4	4.96
10.00									04	4.76
9.525	09	11							T3	3.97
8.00									03	3.18
6.35	06	07							T2	2.58
6.00									02	2.38
5.56									T1	1.98
5.50									01	1.59
3.97									T0	0.99
									00	0.79

**12 04 08 - GF (ISO)**  
**4 3 2 (inch)**

Inscribed Circle		Thickness		Nose Radius		Nose Radius Code		Chip-Breaker Code		
Code	Diameter of IC(mm)	Code	Thickness (mm)	Code	Nose Radius (mm)	Code	Nose Radius (mm)	GF	GM	TM
2	6.35	2	3.18	0	0.2	00	No Radius			
3	9.525	3	4.76	1	0.4	02	0.2			
4	12.7	4	6.35	2	0.8	04	0.4			
5	15.875	5	7.94	3	1.2	08	0.8			
6	19.05	6	9.52	4	1.6	12	1.2			
8	25.4			5	2.0	16	1.6			
				6	2.4	20	2.0			
						24	2.4			
						32	3.2			
						X	Others			
							Diameter of Inserts (Metric)			
							Round Inserts			

## Overview

### ● Negative insert

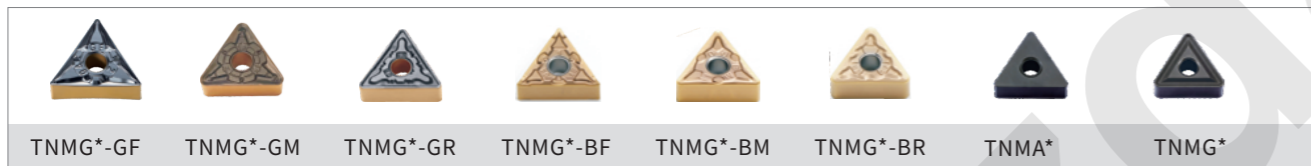
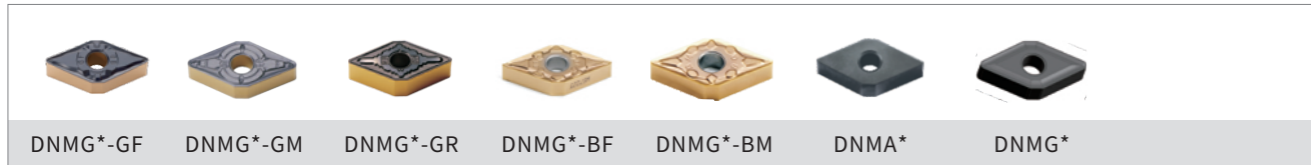

### ● Positive Insert

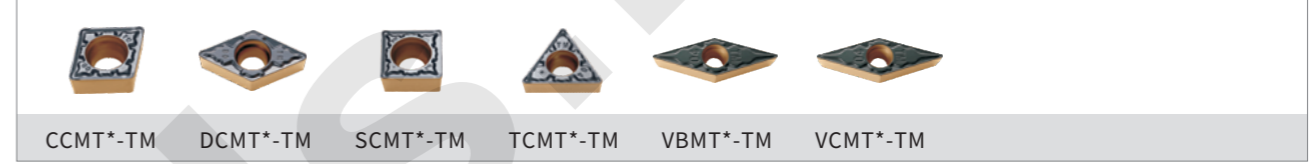

### ● Aluminium insert

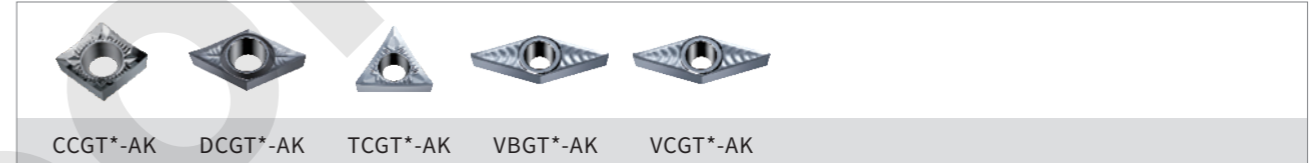



New Grade

WS8215\WS8135

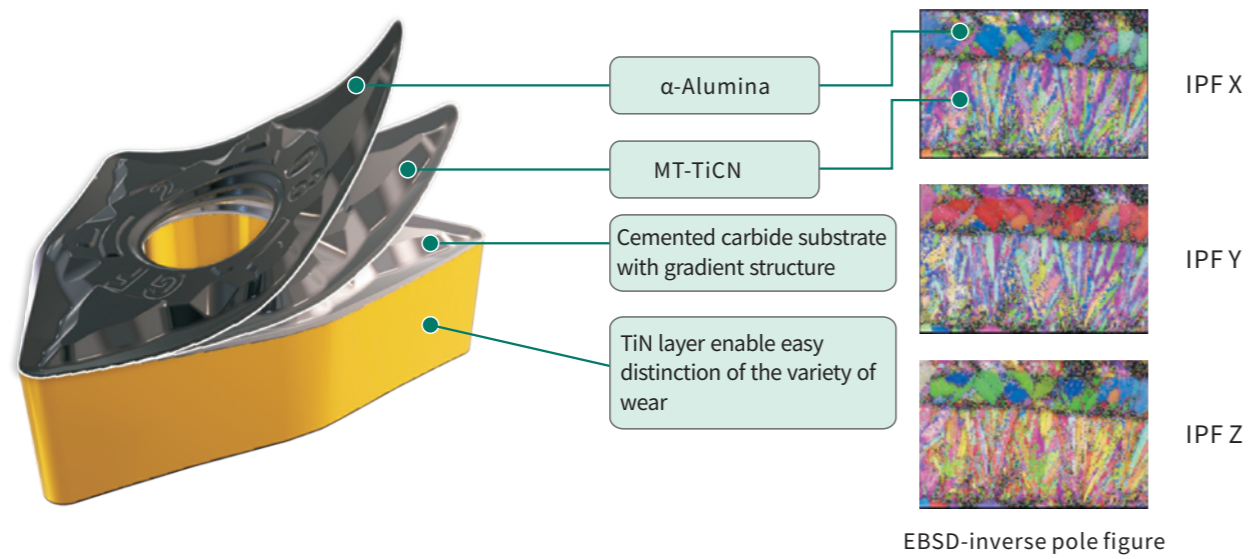

WS8215\WS8135

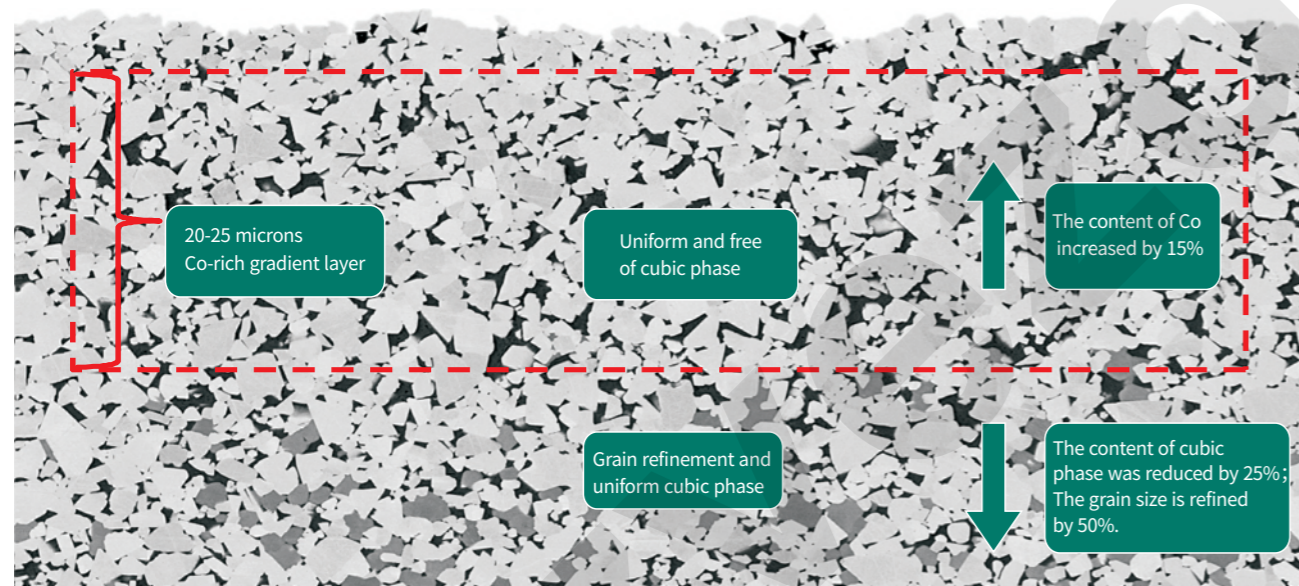

Introduction of chip-breaker

Steel machining

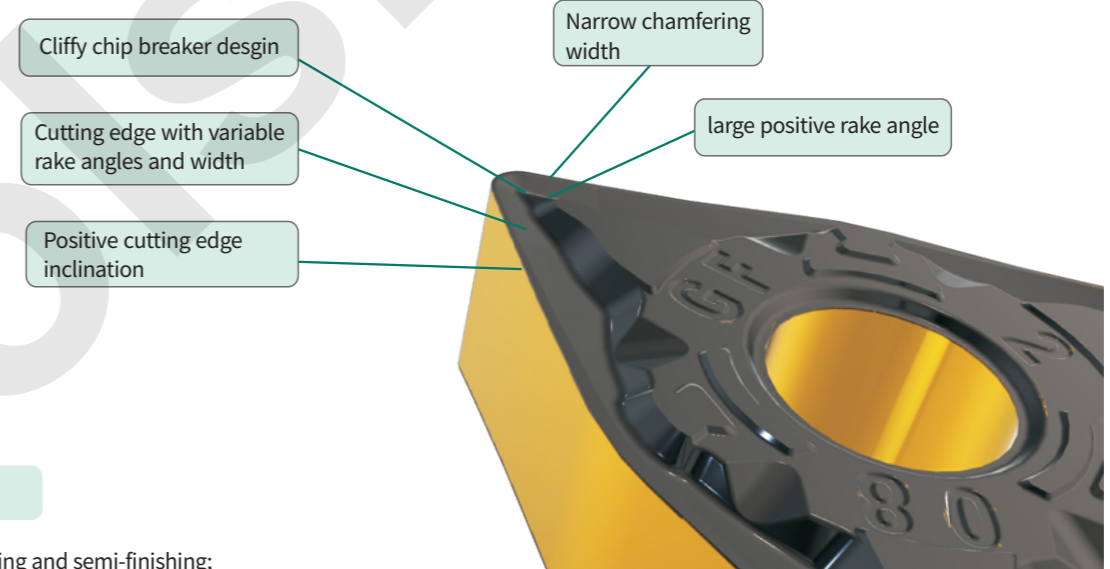

GF

- ◆ Used for finishing and semi-finishing;
- ◆ Large positive rake angle for smaller cutting resistance
- ◆ Positive cutting edge inclination effectively controls the cutting flow direction
- ◆ Two-section chip-breaker design ensures good chip breaking performance at small depth of cut.

GM

- ◆ Used for semi-finishing and realizes high-efficiency and high-stability machining.
- ◆ Specially designed cutting edge perfectly combines sharpness and strength; Curved rake face consists of cutting edge with variable rake angles and width that makes controlling the chipping fow direction valid.
- ◆ Good versatility with a wide range of cutting.

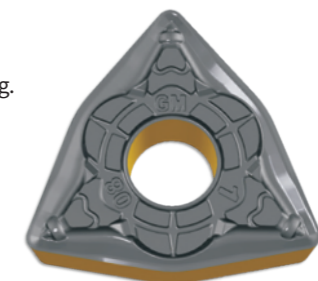

GR

- ◆ Used for light-load roughing, semi-fnishing.
- ◆ The cutting edge of chip-breaker makes controlling the chipping flow direction valid at small depth of cut.
- ◆ Specially designed large rake angle with wide land combine sharpness and strength.
- ◆ Good chip breaking performance and versatility with economical double-face chipbreaker.

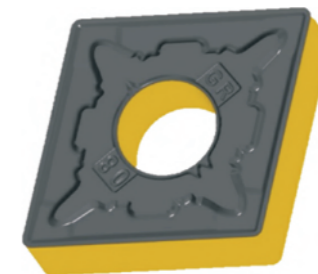

## Stainless steel machining

### Features

- ◆ Specially designed chip-breaker is excellent in roughing , semi-finishing and finishing of stainless steel.
- ◆ BF chip-breaker used for finishing, semi-finishing and achieve good surface quality. Specially designed chip-breaker effectively eliminat the phenomena of burr.
- ◆ BM chip-breaker used for semi-finishing ,roughing and combine sharpness and strength. It is first choice for machining of stainless steel.
- ◆ Effectively cut off stainless steel and avoid adhering and surface hardening, achieving high surface quality.
- ◆ Specially designed chip-breaker makes controlling the chipping flow direction valid, which enables it to cut lightly and easily and reduce the occurrence of built-up edges.
- ◆ Different designs of cutting edge for roughing, semi-finishing and finishing.
- ◆ Inserts for finishing and semi-finishing focus on the sharpness of the cutting edge and inserts for roughing focus on optimal design of cutting edge, which achieves balance between edge security and sharpness and improve the efficiency of the insert.

### Features of chip-breaker

#### BF

- ◆ Used for finishing and semi-finishing.
- ◆ Sharp cutting edge, small cutting resistance.
- ◆ Good chip breaking performance at small depth of cut.
- ◆ Special edge treatment reduce the occurrence of built-up edges.

#### BM

- ◆ Used for semi-finishing and roughing
- ◆ Cutting edge is designed to combine sharpness and strength with a wide range of cutting.
- ◆ Good chip breaking performance, small cutting resistance.

#### BR

- ◆ Sturdy cutting land, used for interrupted machining and roughing.
- ◆ Well-proportioned cutting edge passivation.
- ◆ Optimized chipbreaker.
- ◆ Large space of chip-breaker is suited to roughing at high feed rate.

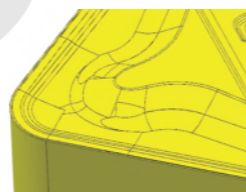
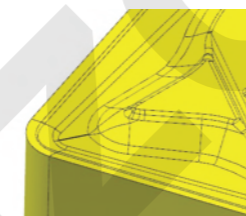
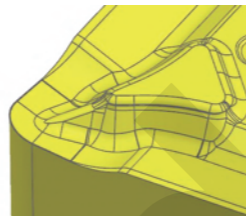

## Cast iron machining

### Features of chip-breaker

#### All round

- ◆ Double-sided chip-breaker with good versatility for K-type materials.
- ◆ Recommended cutting parameters:  $a_p:0.20-8.00$   $f_n:0.15-0.60$

#### Without Chip-breaker

- ◆ Brittle and high hardness materials with high cutting edge strength ensure a perfect fit of holder. It is suitable for machining cast iron under unstable working conditions.

### Positive chip-breaker

#### TM

- ◆ Used for semi-finishing with good versatility.
- ◆ With M-level tolerance, it is suitable for internal and external machining of steel, stainless steel, cast iron, etc.

## Parting and grooving

### Features

- ◆ QCMB can be used for grooving and turning with good versatility.
- ◆ Optimized 3D chip-breaker makes controlling the chipping flow direction valid, which reduce the cutting resistance and the vibration in machining.
- ◆ The parting and grooving insert combines specially developed cemented carbide substrate and coating that achieves the balance between wear resistance and toughness, also improves the tool life and reliability.



## Parting and grooving

### Features of chip-breaker

#### M

- Used for parting, grooving and turning etc. Enables it to cut lightly and easily, unobstructed chip flow and improve the surface quality.

#### T

- With specially designed flank, the cutting resistance can reduce by 20% and also reduces the vibration in machining and improve the surface quality. Specially designed cutting edge provides excellent chip breaking performance and can be transverse cutting feed.



### Processing methods

External parting	External grooving
Face grooving	Internal grooving

### Negative Insert

80° CN\*\* With Hole



● Good working condition ● Normal working condition ■ Bad working condition

Shape	Description	Diagram						Coatings										Cutting Parameters						
		L	IC	S	ød	Re	CVD Coating					PVD Coating					un-coated	Ap (mm)	Fn (mm/r)					
							WS8215	WS8135	WS8133	WS6115	WS7120	WS7140	WS5115	WS5120	WS5130	WS5225				WS5231	WS7125	WS7225	WS7130	WSK10
	CNMG120404-GF	12.9	12.7	4.76	5.16	0.4	●	●														0.15-2.0	0.08-0.18	
	CNMG120408-GF	12.9	12.7	4.76	5.16	0.8	●	●															0.25-2.0	0.08-0.25
	CNMG120404-GM	12.9	12.7	4.76	5.16	0.4	●	●															0.6-5.0	0.2-0.25
	CNMG120408-GM	12.9	12.7	4.76	5.16	0.8	●	●															0.8-5.0	0.2-0.40
	CNMG120412-GM	12.9	12.7	4.76	5.16	1.2	●	●															1.0-5.0	0.20-0.50
	CNMG160608-GM	16.1	15.875	6.35	6.35	0.8	●	●															1.5-6.0	0.15-0.40
	CNMG160612-GM	16.1	15.875	6.35	6.35	1.2	●	●															1.5-6.0	0.20-0.60
	CNMG120408-GR	12.9	12.7	4.76	5.16	0.8	●																2.0-6.5	0.28-0.50
	CNMG120412-GR	12.9	12.7	4.76	5.16	1.2	●																2.0-6.5	0.28-0.63
	CNMG190608-GR	19.3	19.05	6.35	7.94	0.8	●																2.0-8.0	0.30-0.60
	CNMG120404-BF	12.9	12.7	4.76	5.16	0.4																	0.1-2.0	0.08-0.18
	CNMG120408-BF	12.9	12.7	4.76	5.16	0.8																	0.1-2.0	0.08-0.18
	CNMG120404-BM	12.9	12.7	4.76	5.16	0.4																	0.4-5.5	0.10-0.25
	CNMG120408-BM	12.9	12.7	4.76	5.16	0.8																	0.5-5.5	0.10-0.40
	CNMG120412-BM	12.9	12.7	4.76	5.16	1.2																	0.8-5.5	0.10-0.55
	CNMG120408-BR	12.9	12.7	4.76	5.16	0.8																	1.5-6.0	0.25-0.40
	CNMG120412-BR	12.9	12.7	4.76	5.16	1.2																	1.5-6.0	0.25-0.55
	CNMG190616-BR	19.3	19.05	6.35	7.94	1.6																	3.0-8.0	0.25-0.80

## Negative Insert

80° CN\*\* With Hole





● Good working condition ● Normal working condition ■ Bad working condition

Shape	Description	CVD Coating					PVD Coating					un-coated	Cutting Parameters											
		L	IC	S	ød	Re	WS8215	WS8135	WS8133	WS6115	WS7120		WS7140	WS5115	WS5120	WS5130	WS5225	WS5231	WS7125	WS7225	WS7130	WSK10	Ap	Fn
							(mm)	(mm/r)																
	CNMA120404	12.9	12.7	4.76	5.16	0.4	●															1.0-4.5	0.15-0.25	
	CNMA120408	12.9	12.7	4.76	5.16	0.8	●															1.0-4.5	0.15-0.40	
	CNMA120412	12.9	12.7	4.76	5.16	1.2	●															1.0-4.5	0.15-0.55	
	CNMA120416	12.9	12.7	4.76	5.16	1.6	●															1.0-4.5	0.15-0.60	
	CNMA160608	16.1	15.875	6.35	6.35	0.8	●															2.0-6.0	0.15-0.40	
	CNMA160612	16.1	15.875	6.35	6.35	1.2	●															2.0-6.0	0.15-0.55	
	CNMA160616	16.1	15.875	6.35	6.35	1.6	●															2.0-6.0	0.15-0.70	
	CNMA190612	19.3	19.05	6.35	7.94	1.2	●															3.0-8.0	0.15-0.55	
	CNMA190616	19.3	19.05	6.35	7.94	1.6	●															3.0-8.0	0.15-0.80	
		CNMG120404	12.9	12.7	4.76	5.16	0.4	●															1.0-4.5	0.15-0.25
CNMG120408		12.9	12.7	4.76	5.16	0.8	●															1.0-4.5	0.15-0.40	
CNMG120412		12.9	12.7	4.76	5.16	1.2	●															1.0-4.5	0.15-0.55	
CNMG120416		12.9	12.7	4.76	5.16	1.6	●															1.0-4.5	0.15-0.60	
CNMG160608		16.1	15.875	6.35	6.35	0.8	●															2.0-6.0	0.15-0.40	
CNMG160612		16.1	15.875	6.35	6.35	1.2	●															2.0-6.0	0.15-0.55	
CNMG160616		16.1	15.875	6.35	6.35	1.6	●															2.0-6.0	0.15-0.70	
CNMG190612		19.3	19.05	6.35	7.94	1.2	●															3.0-8.0	0.15-0.55	
CNMG190616		19.3	19.05	6.35	7.94	1.6	●															3.0-8.0	0.15-0.80	

## Negative Insert

55° DN\*\* With Hole

● Good working condition ● Normal working condition ■ Bad working condition

Shape	Description	CVD Coating					PVD Coating					un-coated	Cutting Parameters												
		L	IC	S	ød	Re	WS8215	WS8135	WS8133	WS6115	WS7120		WS7140	WS5115	WS5120	WS5130	WS5225	WS5231	WS7125	WS7225	WS7130	WSK10	Ap	Fn	
							(mm)	(mm/r)																	
	DNMG150404-GF	15.5	12.7	4.76	5.16	0.4	●	●															0.15-2.0	0.08-0.18	
	DNMG150408-GF	15.5	12.7	4.76	5.16	0.8	●	●															0.25-2.0	0.08-0.25	
	DNMG150604-GF	15.5	12.7	6.35	5.16	0.4	●	●															0.15-2.0	0.08-0.18	
	DNMG150608-GF	15.5	12.7	6.35	5.16	0.8	●	●															0.25-2.0	0.08-0.25	
		DNMG150404-GM	15.5	12.7	4.76	5.16	0.4	●	●															0.6-4.0	0.20-0.25
		DNMG150408-GM	15.5	12.7	4.76	5.16	0.8	●	●															0.8-4.0	0.20-0.40
		DNMG150412-GM	15.5	12.7	4.76	5.16	1.2	●	●															1.0-4.0	0.20-0.50
		DNMG150604-GM	15.5	12.7	6.35	5.16	0.4	●	●															0.6-4.0	0.20-0.25
		DNMG150608-GM	15.5	12.7	6.35	5.16	0.8	●	●															0.8-4.0	0.20-0.40
		DNMG150612-GM	15.5	12.7	6.35	5.16	1.2	●	●															1.0-4.0	0.20-0.50
		DNMG150608-GR	15.5	12.7	6.35	5.16	0.8	●																2.0-6.5	0.28-0.50
		DNMG150612-GR	15.5	12.7	6.35	5.16	1.2	●																2.0-6.5	0.28-0.63
			DNMG150404-BF	15.5	12.7	4.76	5.16	0.4															●	0.1-2.0	0.08-0.18
			DNMG150408-BF	15.5	12.7	4.76	5.16	0.8															●	0.1-2.0	0.08-0.18
		DNMG150404-BM	15.5	12.7	4.76	5.16	0.4															●	0.4-4.5	0.10-0.25	
		DNMG150408-BM	15.5	12.7	4.76	5.16	0.8															●	0.5-4.5	0.10-0.40	
		DNMG150412-BM	15.5	12.7	4.76	5.16	1.2															●	0.8-4.5	0.10-0.55	
		DNMG150604-BM	15.5	12.7	6.35	5.16	0.4															●	0.4-4.5	0.10-0.25	
		DNMG150608-BM	15.5	12.7	6.35	5.16	0.8															●	0.5-4.5	0.10-0.40	
		DNMG150612-BM	15.5	12.7	6.35	5.16	1.2															●	0.8-4.5	0.10-0.55	

Negative Insert

55° DN\*\* With Hole

● Good working condition ● Normal working condition ■ Bad working condition

Shape	Description	Diagram					Coating										Cutting Parameters							
		L	IC	S	ød	Re	CVD Coating					PVD Coating					un-coated	Ap (mm)	Fn (mm/r)					
		WS8215	WS8135	WS8133	WS6115	WS7120	WS7140	WS5115	WS5120	WS5130	WS5225	WS5231	WS7125	WS7225	WS7130	WSK10								
	DNMA150404	15.5	12.7	4.76	5.16	0.4	●															1.0-4.5	0.15-0.25	
	DNMA150408	15.5	12.7	4.76	5.16	0.8	●																1.0-4.5	0.15-0.40
	DNMA150412	15.5	12.7	4.76	5.16	1.2	●																1.0-4.5	0.15-0.55
	DNMA150604	15.5	12.7	6.35	5.16	0.4	●																1.0-4.5	0.15-0.25
	DNMA150608	15.5	12.7	6.35	5.16	0.8	●																1.0-4.5	0.15-0.40
	DNMA150612	15.5	12.7	6.35	5.16	1.2	●																1.0-4.5	0.15-0.55
	DNMG150404	15.5	12.7	4.76	5.16	0.4	●																1.0-4.5	0.15-0.25
	DNMG150408	15.5	12.7	4.76	5.16	0.8	●																1.0-4.5	0.15-0.40
	DNMG150412	15.5	12.7	4.76	5.16	1.2	●																1.0-4.5	0.15-0.55
	DNMG150604	15.5	12.7	6.35	5.16	0.4	●																1.0-4.5	0.15-0.25
	DNMG150608	15.5	12.7	6.35	5.16	0.8	●																1.0-4.5	0.15-0.40
	DNMG150612	15.5	12.7	6.35	5.16	1.2	●																1.0-4.5	0.15-0.55

Negative Insert

90° SN\*\* With Hole

● Good working condition ● Normal working condition ■ Bad working condition

Shape	Description	Diagram					Coating										Cutting Parameters										
		L	IC	S	ød	Re	CVD Coating					PVD Coating					un-coated	Ap (mm)	Fn (mm/r)								
		WS8215	WS8135	WS8133	WS6115	WS7120	WS7140	WS5115	WS5120	WS5130	WS5225	WS5231	WS7125	WS7225	WS7130	WSK10											
	SNMG120404-GF	12.7	12.7	4.76	5.16	0.4	●	●																0.15-2.0	0.08-0.18		
	SNMG120408-GF	12.7	12.7	4.76	5.16	0.8	●	●																	0.25-2.0	0.08-0.25	
	SNMG120404-GM	12.7	12.7	4.76	5.16	0.4	●	●																	0.4-5.5	0.10-0.25	
	SNMG120408-GM	12.7	12.7	4.76	5.16	0.8	●	●																	0.5-5.5	0.10-0.40	
	SNMG120412-GM	12.7	12.7	4.76	5.16	1.2	●	●																	0.8-5.5	0.10-0.55	
	SNMG120412-GR	12.7	12.7	4.76	5.16	1.2	●																		2.0-6.5	0.28-0.50	
	SNMG120408-GR	12.7	12.7	4.76	5.16	0.8	●																		2.0-6.5	0.28-0.63	
	SNMG190608-GR	19.05	19.05	6.35	7.94	0.8	●																			2.0-8.0	0.30-0.60
	SNMG190612-GR	19.05	19.05	6.35	7.94	1.2	●																			2.0-8.0	0.40-0.80
	SNMG190616-GR	19.05	19.05	6.35	7.94	1.6	●																			2.0-8.0	0.50-1.00
	SNMM190612-GZ	19.05	19.05	6.35	7.94	1.2	●	●																		3.0-10.0	0.50-0.80
	SNMM190624-GZ	19.05	19.05	6.35	7.94	2.4	●	●																		3.0-10.0	0.50-1.20
	SNMM250724-CR	25.4	25.4	7.94	9.12	2.4	●	●																		5.0-15.0	0.60-1.40
	SNMM250924-CR	25.4	25.4	9.52	9.12	2.4	●	●																		5.0-15.0	0.60-1.40
	SNMG120404-HAF	12.7	12.7	4.76	5.16	0.4																					
	SNMG120404-HSF	12.7	12.7	4.76	5.16	0.4																					
	SNMG120404-BF	12.7	12.7	4.76	5.16	0.4																		●	0.1-2.0	0.08-0.18	
	SNMG120408-BF	12.7	12.7	4.76	5.16	0.8																		●	0.1-2.0	0.08-0.18	
	SNMG120404-BM	12.7	12.7	4.76	5.16	0.4																		●	0.4-5.5	0.10-0.25	
	SNMG120408-BM	12.7	12.7	4.76	5.16	0.8																		●	0.5-5.5	0.10-0.40	
	SNMG120412-BM	12.7	12.7	4.76	5.16	1.2																		●	0.8-5.5	0.10-0.55	
	SNMG120408-BR	12.7	12.7	4.76	5.16	0.8																		●	1.5-6.0	0.25-0.40	
	SNMG120412-BR	12.7	12.7	4.76	5.16	1.2																		●	1.5-6.0	0.25-0.55	

Negative Insert

90° SN\*\* With Hole

● Good working condition ● Normal working condition ■ Bad working condition

Shape	Description	Diagram					Coating										Cutting Parameters					
		L	IC	S	ød	Re	CVD Coating					PVD Coating					un-coated	Ap (mm)	Fn (mm/r)			
							WS8215	WS8135	WS8133	WS6115	WS7120	WS7140	WS5115	WS5120	WS5130	WS5225				WS5231	WS7125	WS7225
	SNMA120404	12.7	12.7	4.76	5.16	0.4	●														1.0-4.5	0.15-0.25
	SNMA120408	12.7	12.7	4.76	5.16	0.8	●														1.0-4.5	0.15-0.40
	SNMA120412	12.7	12.7	4.76	5.16	1.2	●														1.0-4.5	0.15-0.55
	SNMA150608	15.875	15.875	6.35	6.35	0.8	●														2.0-6.0	0.15-0.40
	SNMA150612	15.875	15.875	6.35	6.35	1.2	●														2.0-6.0	0.15-0.55
	SNMA150616	15.875	15.875	6.35	6.35	1.6	●														2.0-6.0	0.15-0.70
	SNMA190612	19.05	19.05	6.35	7.94	1.2	●														3.0-8.0	0.15-0.55
	SNMA190616	19.05	19.05	6.35	7.94	1.6	●														3.0-8.0	0.15-0.80
	SNMG120404	12.7	12.7	4.76	5.16	0.4	●														1.0-4.5	0.15-0.25
	SNMG120408	12.7	12.7	4.76	5.16	0.8	●														1.0-4.5	0.15-0.40
	SNMG120412	12.7	12.7	4.76	5.16	1.2	●														1.0-4.5	0.15-0.55
	SNMG150608	15.875	15.875	6.35	6.35	0.8	●														2.0-6.0	0.15-0.40
	SNMG150612	15.875	15.875	6.35	6.35	1.2	●														2.0-6.0	0.15-0.55
	SNMG150616	15.875	15.875	6.35	6.35	1.6	●														2.0-6.0	0.15-0.70
	SNMG190612	19.05	19.05	6.35	7.94	1.2	●														3.0-8.0	0.15-0.55
	SNMG190616	19.05	19.05	6.35	7.94	1.6	●														3.0-8.0	0.15-0.80

Negative Insert

60° TN\*\* With Hole

● Good working condition ● Normal working condition ■ Bad working condition

Shape	Description	Diagram					Coating										Cutting Parameters							
		L	IC	S	ød	Re	CVD Coating					PVD Coating					un-coated	Ap (mm)	Fn (mm/r)					
							WS8215	WS8135	WS8133	WS6115	WS7120	WS7140	WS5115	WS5120	WS5130	WS5225				WS5231	WS7125	WS7225	WS7130	WSK10
	TNMG160404-GF	16.5	9.525	4.76	3.81	0.4	●	●														0.15-2.0	0.08-0.18	
	TNMG160408-GF	16.5	9.525	4.76	3.81	0.8	●	●															0.25-2.0	0.08-0.25
	TNMG160404-GM	16.5	9.525	4.76	3.81	0.4	●	●															0.4-4.5	0.10-0.25
	TNMG160408-GM	16.5	9.525	4.76	3.81	0.8	●	●															0.5-4.5	0.10-0.40
	TNMG160412-GM	16.5	9.525	4.76	3.81	1.2	●	●															0.8-4.5	0.10-0.55
	TNMG220412-GM	22	12.7	4.76	5.16	1.2	●	●															2.0-6.5	0.28-0.50
	TNMG160408-GR	16.5	9.525	4.76	3.81	0.8	●																2.0-6.5	0.28-0.50
	TNMG160412-GR	16.5	9.525	4.76	3.81	1.2	●																2.0-6.5	0.28-0.63
	TNMG160404-BF	16.5	9.525	4.76	3.81	0.4																●	0.1-2.0	0.08-0.18
	TNMG160408-BF	16.5	9.525	4.76	3.81	0.8																●	0.1-2.0	0.08-0.18
	TNMG160404-BM	16.5	9.525	4.76	3.81	0.4																●	0.4-4.5	0.10-0.25
	TNMG160408-BM	16.5	9.525	4.76	3.81	0.8																●	0.5-4.5	0.10-0.40
	TNMG160412-BM	16.5	9.525	4.76	3.81	1.2																●	0.8-4.5	0.10-0.55
	TNMG160408-BR	16.5	9.525	4.76	3.81	0.8			●													●	1.5-5.0	0.25-0.40
	TNMG160412-BR	16.5	9.525	4.76	3.81	1.2			●													●	1.5-5.0	0.25-0.55
	TNMA160404	16.5	9.525	4.76	3.81	0.4			●														1.0-4.5	0.15-0.25
	TNMA160408	16.5	9.525	4.76	3.81	0.8			●														1.0-4.5	0.15-0.40
	TNMA160412	16.5	9.525	4.76	3.81	1.2			●														1.0-4.5	0.15-0.55
	TNMA220408	22	12.7	4.76	5.16	0.8			●														2.0-6.0	0.15-0.40
	TNMA220412	22	12.7	4.76	5.16	1.2			●														2.0-6.0	0.15-0.55
	TNMA220416	22	12.7	4.76	5.16	1.6			●														2.0-6.0	0.15-0.70

Negative Insert

60° TN\*\* With Hole

● Good working condition ● Normal working condition ■ Bad working condition

Shape	Description						CVD Coating		PVD Coating		un-coated	Cutting Parameters											
							WS8215	WS8135	WS8133	WS6115	WS7120	WS7140	WS5115	WS5120	WS5130	WS5225	WS5231	WS7125	WS7225	WS7130	WSK10	Ap	Fn
							(mm)	(mm/r)	(mm)	(mm/r)													
	TNMG160404	16.5	9.525	4.76	3.81	0.4	●	●									1.0-4.5	0.15-0.25					
	TNMG160408	16.5	9.525	4.76	3.81	0.8	●	●									1.0-4.5	0.15-0.40					
	TNMG160412	16.5	9.525	4.76	3.81	1.2	●	●									1.0-4.5	0.15-0.55					
	TNMG220408	22	12.7	4.76	5.16	0.8	●	●									2.0-6.0	0.15-0.40					
	TNMG220412	22	12.7	4.76	5.16	1.2	●	●									2.0-6.0	0.15-0.55					
	TNMG220416	22	12.7	4.76	5.16	1.6	●	●									2.0-6.0	0.15-0.70					

35° VN\*\* With Hole

● Good working condition ● Normal working condition ■ Bad working condition

Shape	Description						CVD Coating		PVD Coating		un-coated	Cutting Parameters											
							WS8215	WS8135	WS8133	WS6115	WS7120	WS7140	WS5115	WS5120	WS5130	WS5225	WS5231	WS7125	WS7225	WS7130	WSK10	Ap	Fn
							(mm)	(mm/r)	(mm)	(mm/r)													
	VNMG160404-GF	16.6	9.525	4.76	3.81	0.4	●	●									0.15-2.0	0.08-0.18					
	VNMG160408-GF	16.6	9.525	4.76	3.81	0.8	●	●									0.25-2.0	0.08-0.25					
	VNMG160404-GM	16.6	9.525	4.76	3.81	0.4	●	●									0.4-4.0	0.10-0.25					
	VNMG160408-GM	16.6	9.525	4.76	3.81	0.8	●	●									0.5-4.0	0.10-0.40					
	VNMG160412-GM	16.6	9.525	4.76	3.81	1.2	●	●									0.8-4.0	0.10-0.55					
	VNMG160404-BF	16.6	9.525	4.76	3.81	0.4							●				0.1-2.0	0.08-0.18					
	VNMG160408-BF	16.6	9.525	4.76	3.81	0.8							●				0.1-2.0	0.08-0.18					
	VNMG160404-BM	16.6	9.525	4.76	3.81	0.4							●				0.4-4.5	0.10-0.25					
	VNMG160408-BM	16.6	9.525	4.76	3.81	0.8							●				0.5-4.5	0.10-0.40					
	VNMG160412-BM	16.6	9.525	4.76	3.81	1.2							●				0.8-4.5	0.10-0.55					
	VNMA160404	16.6	9.525	4.76	3.81	0.4							●				1.0-4.5	0.15-0.25					
	VNMA160408	16.6	9.525	4.76	3.81	0.8							●				1.0-4.5	0.15-0.40					
	VNMG160404	16.6	9.525	4.76	3.81	0.4							●				1.0-4.5	0.15-0.25					
	VNMG160408	16.6	9.525	4.76	3.81	0.8							●				1.0-4.5	0.15-0.40					

Negative Insert

80° WN\*\* With Hole

● Good working condition ● Normal working condition ■ Bad working condition

Shape	Description						CVD Coating		PVD Coating		un-coated	Cutting Parameters											
							WS8215	WS8135	WS8133	WS6115	WS7120	WS7140	WS5115	WS5120	WS5130	WS5225	WS5231	WS7125	WS7225	WS7130	WSK10	Ap	Fn
							(mm)	(mm/r)	(mm)	(mm/r)													
	WNMG080404-GF	8.7	12.7	4.76	5.16	0.4	●	●									0.15-2.0	0.08-0.18					
	WNMG080408-GF	8.7	12.7	4.76	5.16	0.8	●	●									0.25-2.0	0.08-0.25					
	WNMG080404-GM	8.7	12.7	4.76	5.16	0.4	●	●									0.4-5.5	0.10-0.25					
	WNMG080408-GM	8.7	12.7	4.76	5.16	0.8	●	●									0.5-5.5	0.10-0.40					
	WNMG080412-GM	8.7	12.7	4.76	5.16	1.2	●	●									0.8-5.5	0.10-0.55					
	WNMG080408-GR	8.7	12.7	4.76	5.16	0.8	●	●									2.0-6.5	0.28-0.50					
	WNMG080412-GR	8.7	12.7	4.76	5.16	1.2	●	●									2.0-6.5	0.28-0.63					
	WNMG080404-BF	8.7	12.7	4.76	5.16	0.4								●			0.1-2.0	0.08-0.18					
	WNMG080408-BF	8.7	12.7	4.76	5.16	0.8							●				0.1-2.0	0.08-0.18					
	WNMG06T312-BM	6.6	9.525	3.97	3.81	0.8							●				0.8-3.0	0.10-0.55					
	WNMG060412-BM	6.6	9.525	4.76	3.81	0.8							●				0.8-3.0	0.10-0.55					
	WNMG080404-BM	8.7	12.7	4.76	5.16	0.4							●				0.4-5.5	0.10-0.25					
	WNMG080408-BM	8.7	12.7	4.76	5.16	0.8							●				0.5-5.5	0.10-0.40					
	WNMG080412-BM	8.7	12.7	4.76	5.16	1.2							●				0.8-5.5	0.10-0.55					
	WNMG080408-BR	8.7	12.7	4.76	5.16	0.8							●	●			1.5-6.0	0.25-0.40					
	WNMG080412-BR	8.7	12.7	4.76	5.16	1.2							●	●			1.5-6.0	0.25-0.55					
	WNMA060404	6.6	9.525	4.76	3.81	0.4							●				0.5-3.0	0.15-0.25					
	WNMA060408	6.6	9.525	4.76	3.81	0.8							●				0.5-3.0	0.15-0.40					
	WNMA080404	8.7	12.7	4.76	5.16	0.4							●				1.0-4.5	0.15-0.25					
	WNMA080408	8.7	12.7	4.76	5.16	0.8							●				1.0-4.5	0.15-0.40					
	WNMA080412	8.7	12.7	4.76	5.16	1.2							●				1.0-4.5	0.15-0.55					
	WNMA080416	8.7	12.7	4.76	5.16	1.6							●				1.0-4.5	0.15-0.60					

Negative Insert

80° WN\*\* With Hole

● Good working condition ● Normal working condition ■ Bad working condition

Shape	Description	Diagram					Coating										Cutting Parameters						
		L	IC	S	ød	Re	CVD Coating					PVD Coating					un-coated	Ap (mm)	Fn (mm/r)				
							WS8215	WS8135	WS8133	WS6115	WS7120	WS7140	WS5115	WS5120	WS5130	WS5225				WS5231	WS7125	WS7225	WS7130
	WNMG060404	6.6	9.525	4.76	3.81	0.4	●															0.5-3	0.15-0.40
	WNMG060408	6.6	9.525	4.76	3.81	0.8	●															1.0-4.5	0.15-0.25
	WNMG080404	8.7	12.7	4.76	5.16	0.4	●															1.0-4.5	0.15-0.40
	WNMG080408	8.7	12.7	4.76	5.16	0.8	●															1.0-4.5	0.15-0.55
	WNMG080412	8.7	12.7	4.76	5.16	1.2	●															1.0-4.5	0.15-0.60

Positive Insert

80° CC\*\* With Hole

● Good working condition ● Normal working condition ■ Bad working condition

Shape	Description	Diagram					Coating										Cutting Parameters							
		L	IC	S	ød	Re	CVD Coating					PVD Coating					un-coated	Ap (mm)	Fn (mm/r)					
							WS8215	WS8135	WS8133	WS6115	WS7120	WS7140	WS5115	WS5120	WS5130	WS5225				WS5231	WS7125	WS7225	WS7130	WSK10
	CCMT060204-TM	6.4	6.35	2.38	2.8	0.4	●	●	●														0.2-2.0	0.06-0.20
	CCMT060208-TM	6.4	6.35	2.38	2.8	0.8	●	●	●														0.2-2.0	0.08-0.30
	CCMT09T304-TM	9.7	9.525	3.97	4.4	0.4	●	●	●														0.3-3.0	0.08-0.25
	CCMT09T308-TM	9.7	9.525	3.97	4.4	0.8	●	●	●														0.3-3.0	0.10-0.30
	CCMT120404-TM	12.9	12.7	4.76	5.56	0.4	●	●	●														0.3-3.5	0.10-0.25
	CCMT120408-TM	12.9	12.7	4.76	5.56	0.8	●	●	●														0.3-3.5	0.20-0.40
	CCMT120412-TM	12.9	12.7	4.76	5.56	1.2	●	●	●														0.3-3.5	0.20-0.50
	CCGT060202-AK	6.4	6.35	2.38	2.8	0.2																●	0.05-3.0	0.01-0.12
	CCGT060204-AK	6.4	6.35	2.38	2.8	0.4																●	0.1-3.0	0.02-0.20
	CCGT09T302-AK	9.7	9.525	3.97	4.4	0.2																●	0.1-5.0	0.02-0.15
	CCGT09T304-AK	9.7	9.525	3.97	4.4	0.4																●	0.1-5.0	0.02-0.25
	CCGT120404-AK	12.9	12.7	4.76	5.56	0.4																●	0.1-5.0	0.02-0.40
	CCGT120408-AK	12.9	12.7	4.76	5.56	0.8																●	0.1-5.0	0.02-0.60

55° DC\*\* With Hole

● Good working condition ● Normal working condition ■ Bad working condition

Shape	Description	Diagram					Coating										Cutting Parameters							
		L	IC	S	ød	Re	CVD Coating					PVD Coating					un-coated	Ap (mm)	Fn (mm/r)					
							WS8215	WS8135	WS8133	WS6115	WS7120	WS7140	WS5115	WS5120	WS5130	WS5225				WS5231	WS7125	WS7225	WS7130	WSK10
	DCMT070204-TM	7.8	6.35	2.38	2.8	0.4	●	●	●														0.2-2.0	0.06-0.20
	DCMT070208-TM	7.8	6.35	2.38	2.8	0.8	●	●	●														0.2-2.0	0.08-0.30
	DCMT11T304-TM	11.6	9.525	3.97	4.4	0.4	●	●	●														0.3-3.0	0.08-0.25
	DCMT11T308-TM	11.6	9.525	3.97	4.4	0.8	●	●	●														0.3-3.0	0.10-0.30
	DCMT11T312-TM	11.6	9.525	3.97	4.4	1.2	●	●	●														0.3-3.0	0.10-0.40
	DCGT070202-AK	7.8	6.35	2.38	2.8	0.2																●	0.05-3.0	0.01-0.12
	DCGT070204-AK	7.8	6.35	2.38	2.8	0.4																●	0.1-3.0	0.02-0.20
	DCGT11T302-AK	11.6	9.525	3.97	4.4	0.2																●	0.05-4.0	0.02-0.20
	DCGT11T304-AK	11.6	9.525	3.97	4.4	0.4																●	0.1-4.0	0.02-0.25



## Positive Insert



90° SC\*\* With Hole

● Good working condition ● Normal working condition ■ Bad working condition

Shape	Description	CVD Coating						PVD Coating						un-coated	Cutting Parameters									
		L	IC	S	ød	Re	WS8215	WS8135	WS8133	WS6115	WS7120	WS7140	WS5115		WS5120	WS5130	WS5225	WS5231	WS7125	WS7225	WS7130	WSK10	Ap	Fn
							(mm)	(mm/r)																
	SCMT09T304-TM	9.525	9.525	3.97	4.4	0.4	●	●	●	●	●	●	●	●	●	●	●	●	●	●	●	0.3-3.0	0.08-0.25	
	SCMT09T308-TM	9.525	9.525	3.97	4.4	0.8	●	●	●	●	●	●	●	●	●	●	●	●	●	●	●	0.3-3.0	0.10-0.30	
	SCMT120404-TM	12.7	12.7	4.76	5.56	0.4	●	●	●	●	●	●	●	●	●	●	●	●	●	●	●	0.3-3.5	0.10-0.25	
	SCMT120408-TM	12.7	12.7	4.76	5.56	0.8	●	●	●	●	●	●	●	●	●	●	●	●	●	●	●	0.3-3.5	0.20-0.40	
	SCMT120412-TM	12.7	12.7	4.76	5.56	1.2	●	●	●	●	●	●	●	●	●	●	●	●	●	●	●	0.3-3.5	0.20-0.50	

60° TC\*\* With Hole

● Good working condition ● Normal working condition ■ Bad working condition

Shape	Description	CVD Coating						PVD Coating						un-coated	Cutting Parameters									
		L	IC	S	ød	Re	WS8215	WS8135	WS8133	WS6115	WS7120	WS7140	WS5115		WS5120	WS5130	WS5225	WS5231	WS7125	WS7225	WS7130	WSK10	Ap	Fn
							(mm)	(mm/r)																
	TCMT110204-TM	11.0	6.35	2.38	2.8	0.4	●	●	●	●	●	●	●	●	●	●	●	●	●	●	●	0.3-3.0	0.08-0.25	
	TCMT110208-TM	11.0	6.35	2.38	2.8	0.8	●	●	●	●	●	●	●	●	●	●	●	●	●	●	●	0.3-3.0	0.10-0.30	
	TCMT16T304-TM	16.5	9.525	3.97	4.4	0.4	●	●	●	●	●	●	●	●	●	●	●	●	●	●	●	0.3-3.0	0.08-0.25	
	TCMT16T308-TM	16.5	9.525	3.97	4.4	0.8	●	●	●	●	●	●	●	●	●	●	●	●	●	●	●	0.3-3.0	0.10-0.30	
	TCMT16T312-TM	16.5	9.525	3.97	4.4	1.2	●	●	●	●	●	●	●	●	●	●	●	●	●	●	●	0.3-3.0	0.10-0.40	
	TCGT090204-AK	9.7	5.56	2.38	2.8	0.4	●	●	●	●	●	●	●	●	●	●	●	●	●	●	●	0.05-3.0	0.01-0.12	
	TCGT110204-AK	11.0	6.35	2.38	2.8	0.4	●	●	●	●	●	●	●	●	●	●	●	●	●	●	●	0.1-4.0	0.03-0.20	
	TCGT16T304-AK	16.5	9.525	3.97	4.4	0.4	●	●	●	●	●	●	●	●	●	●	●	●	●	●	●	0.1-5.0	0.02-0.25	

## Positive Insert

35° VB&VC\*\* With Hole

● Good working condition ● Normal working condition ■ Bad working condition

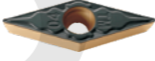
Shape	Description	CVD Coating						PVD Coating						un-coated	Cutting Parameters										
		L	IC	S	ød	Re	a	WS8215	WS8135	WS8133	WS6115	WS7120	WS7140		WS5115	WS5120	WS5130	WS5225	WS5231	WS7125	WS7225	WS7130	WSK10	Ap	Fn
								(mm)	(mm/r)																
	VBMT110304-TM	11.0	6.35	3.18	2.8	0.4	5.0	●	●	●	●	●	●	●	●	●	●	●	●	●	●	0.2-2.0	0.06-0.20		
	VBMT110308-TM	11.0	6.35	3.18	2.8	0.8	5.0	●	●	●	●	●	●	●	●	●	●	●	●	●	●	0.2-2.0	0.08-0.30		
	VBMT160404-TM	16.5	9.525	4.76	4.4	0.4	5.0	●	●	●	●	●	●	●	●	●	●	●	●	●	●	0.3-3.0	0.08-0.25		
	VBMT160408-TM	16.5	9.525	4.76	4.4	0.8	5.0	●	●	●	●	●	●	●	●	●	●	●	●	●	●	0.3-3.0	0.10-0.30		
	VBMT160412-TM	16.5	9.525	4.76	4.4	1.2	5.0	●	●	●	●	●	●	●	●	●	●	●	●	●	●	0.3-3.0	0.10-0.40		
	VCMT110304-TM	11.0	6.35	3.18	2.8	0.4	7.0	●	●	●	●	●	●	●	●	●	●	●	●	●	●	0.2-2.0	0.06-0.20		
	VCMT110308-TM	11.0	6.35	3.18	2.8	0.8	7.0	●	●	●	●	●	●	●	●	●	●	●	●	●	●	0.2-2.0	0.08-0.30		
	VCMT160404-TM	16.5	9.525	4.76	4.4	0.4	7.0	●	●	●	●	●	●	●	●	●	●	●	●	●	●	0.3-3.0	0.08-0.25		
	VCMT160408-TM	16.5	9.525	4.76	4.4	0.8	7.0	●	●	●	●	●	●	●	●	●	●	●	●	●	●	0.3-3.0	0.10-0.30		
	VCMT160412-TM	16.5	9.525	4.76	4.4	1.2	7.0	●	●	●	●	●	●	●	●	●	●	●	●	●	●	0.3-3.0	0.10-0.40		
	VBGT160402-AK	16.5	9.525	4.76	4.4	0.2	5.0														●	0.05-4.0	0.03-0.15		
	VBGT160404-AK	16.5	9.525	4.76	4.4	0.4	5.0															●	0.1-5.0	0.03-0.25	
	VBGT160408-AK	16.5	9.525	4.76	4.4	0.8	5.0															●	0.1-5.0	0.03-0.50	
	VCGT110302-AK	11.0	6.35	3.18	2.8	0.2	7.0															●	0.05-3.0	0.01-0.12	
VCGT110304-AK	11.0	6.35	3.18	2.8	0.4	7.0															●	0.05-3.0	0.02-0.15		
VCGT160402-AK	16.5	9.525	4.76	4.4	0.2	7.0															●	0.05-4.0	0.03-0.15		
VCGT160404-AK	16.5	9.525	4.76	4.4	0.4	7.0															●	0.1-5.0	0.03-0.25		
VCGT160408-AK	16.5	9.525	4.76	4.4	0.8	7.0															●	0.1-5.0	0.03-0.50		

## Cases

### Continuous finish turning - Flange

- **Workpiece** Flange 40Cr
- **Machining Methods** Wet-type continuous finish turning of external & end face
- **Insert** DNMG150408-GF WS8215
- **Cutting Conditions**  $V_c=338.5\text{m/min}$ ,  $f=0.14\sim0.32\text{mm/r}$ ,  $a_p=0.2\text{mm}$
- **Result of cutting** Compare with Brand A after 200 pcs/cutting edge, WS8215 shows better surface quality and abrasion resistance.

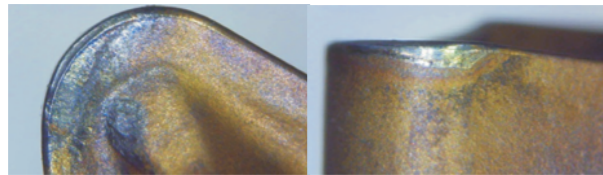
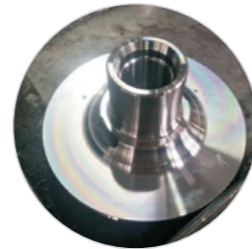

Brand A

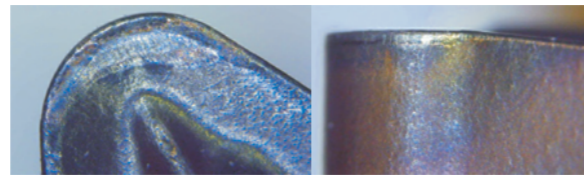

HARDSTONE

### High speed continuous turning - Automobile Hub Unit

- **Workpiece** Automobile Hub unit steel 65Mn
- **Machining Methods** Wet-type continuous finish turning of external & end face
- **Insert** WNMG080408-GF WS8215
- **Cutting Conditions**  $V_c=330\text{m/min}$ ,  $f=0.3\text{mm/r}$ ,  $a_p=0.8\text{mm}$



WS8215 with GF chip-breaker provide excellent chip breaking effect, high surface quality and good wear resistance for high speed continuous turning of steel.

Cutting life	
Hardstone	23~30pcs/edge
Brand A	13~21pcs/edge

### Continuous turning - Bearing

- **Workpiece** Bearing GCr15
- **Machining Methods** Wet-type continuous internal roughing and semi-finishing
- **Insert** VNMG160408-GM WS8215
- **Cutting Conditions**  $V_c=200\text{m/min}$ ,  $f=0.30\text{mm/r}$ ,  $a_p=0.30\sim1.0\text{mm}$

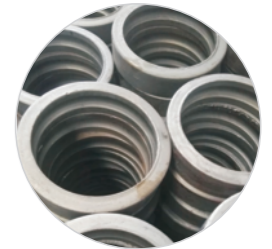

GM type chip-breaker, with smooth chip evacuation and safty cutting edge for continuous roughing, and sharp edge for finishing

Cutting life	
Hardstone	138pcs/edge
Brand A	130~140pcs/edge

### Continuous turning - Flange

- **Workpiece** 65Mn
- **Machining Methods** Wet-type continuous rough turning of external & end face
- **Insert** WNMG080412-GM WS8135
- **Cutting Conditions**  $V_c=260\text{m/min}$ ,  $f=0.32\text{mm/r}$ ,  $a_p=1.0\text{mm}$

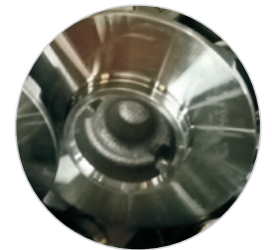

WS8135 with GM chip-breaker, not only applicable for interrupted medium speed roughing, but also with strong versatility.

Cutting life	
Hardstone	100pcs/edge
Brand A	80pcs/edge

## Cases

### Strong interrupted turning - Flange

- **Workpiece** Flange steel 45#
- **Machining Methods** Wet-type rough & finish turning of heavy interrupted end face
- **Insert** WNMG080408-GM WS8135
- **Cutting Conditions**  $V_c=180\sim358\text{m/min}$ ,  $f=0.275\text{mm/r}$ ,  $a_p=1.3/3\text{mm}$



WS8135 matching GM chip-breaker has a strong adaptability to constant speed and variable speed rough turning and fine turning of strongly discontinuous parts.

Cutting life	
Hardstone	33pcs/edge
Brand A	15~25pcs/edge

### Interrupted turning- Flange

- **Workpiece** Quenched and tempered steel 55#
- **Machining Methods** Wet-type finish turning of continuous external and interrupted end face
- **Insert** WNMG080408-GM WS8135
- **Cutting Conditions**  $V_c=285.7\text{m/min}$ ,  $f=0.27\text{mm/r}$ ,  $a_p=0.6\text{mm}$



WS8135 with GM chip-breaker, provide high performance and strong stability for medium and high speed semi-finish turning of workpiece with both continuous and interrupted machining requirements.

Cutting life	
Hardstone	74pcs/edge
Brand A	60~70pcs/edge

### Interrupted turning - Bearing Block

- **Workpiece** Quenched and tempered steel 55#
- **Machining Methods** Wet-type finish turning of continuous external and interrupted end face
- **Insert** WNMG080408-GM WS8135
- **Cutting Conditions**  $V_c=282.6\text{m/min}$ ,  $f=0.225\text{mm/r}$ ,  $a_p=0.5\text{mm}$

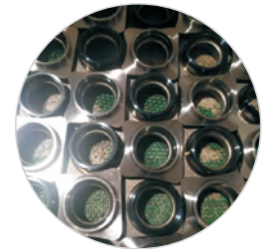

WS8135 with GM chip-breaker, provide high performance and strong stability for medium and high speed semi-finish turning of workpiece with both continuous and interrupted machining requirements.

Cutting life	
Hardstone	70pcs/edge
Brand A	37~48pcs/edge

### Interrupted & continuous turning - Housing

- **Workpiece** Quenched and tempered steel 55#
- **Machining Methods** Wet-type finish turning of continuous external and interrupted end face
- **Insert** WNMG080408-GM WS8135
- **Cutting Conditions**  $V_c=285.7\text{m/min}$ ,  $f=0.27\text{mm/r}$ ,  $a_p=0.6\text{mm}$
- **Result of cutting** Compare with Brand A after testing 21 pcs/cutting edge, all samples shows minor abrasion in rake/flank face, and are of the same life span.

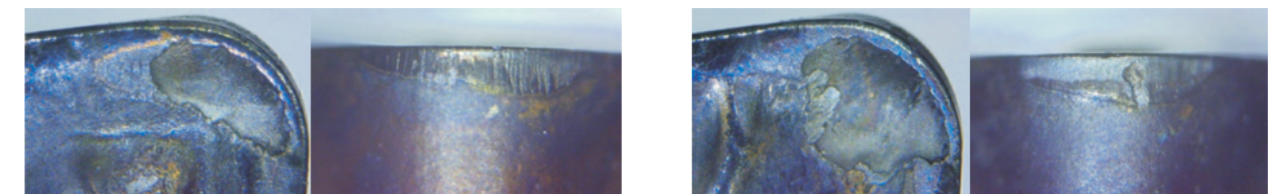

GM

Competitor A

## Cases

### Interrupted / continuous roughing turning - Housing

- **Workpiece** CF53
- **Machining Methods** Wet-type semi-finish turning of continuous & interrupted external
- **Insert** DNMG150408-GM WS8135
- **Cutting Conditions**  $V_c=354\text{m/min}$ ,  $f=0.345\text{mm/r}$ ,  $a_p=0.5\text{mm}$

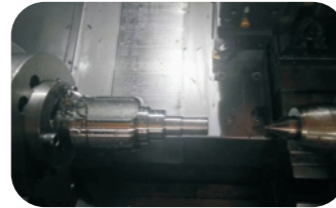

WS8135 with GM chip-breaker, provide strong versatility for ultra-high speed finish turning of workpiece with both continuous and interrupted machining requirements.

Cutting life	
Hardstone	48pcs/edge
Brand A	40~50pcs/edge

### Interrupted and continuous rough turning - Housing

- **Workpiece** CF53
- **Machining Methods** Wet-type rough turning of interrupted shaft journal and continuous small shaft
- **Insert** WNMG080412-GR WS8135
- **Cutting Conditions**  $V_c=351\text{m/min}$ ,  $f=0.45\text{mm/r}$ ,  $a_p=2.0\text{mm}$



WS8135 with GR chip-breaker, provide superior advantages for ultra-high speed, large cutting depth, high feeding rate rough turning of workpiece with both continuous and interrupted machining requirements.

Cutting life	
Hardstone	15pcs/edge
Brand A	9~10pcs/edge

### Interrupted and continuous rough turning - Housing

- **Workpiece** CF53
- **Machining Methods** Wet-type finish turning of interrupted shaft journal and continuous small shaft
- **Insert** DNMG150408-GM WS8135
- **Cutting Conditions**  $V_c=369\text{m/min}$ ,  $f=0.3\text{mm/r}$ ,  $a_p=0.5\text{mm}$



WS8135 with GM chip-breaker, provide strong applicability for ultra-high speed finish turning of workpiece with both continuous and interrupted machining requirements.

Cutting life	
Hardstone	108pcs/edge
Brand A	100pcs/edge

### Continuous rough turning - Slender shaft

- **Workpiece** 45#
- **Machining Methods** Wet-type rough turning of continuous external
- **Insert** DNMG150408-GM WS8135
- **Cutting Conditions**  $V_c=354\text{m/min}$ ,  $f=0.26\text{mm/r}$ ,  $a_p=0.25\text{mm}$

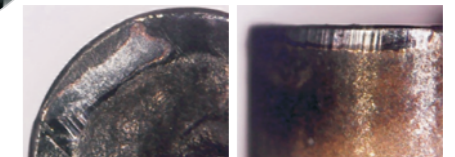

WS8135 with GR chip-breaker, provide very good chip evacuation, excellent surface finish and long lifespan for shaft type workpiece.

Cutting life	
Hardstone	104~110pcs/edge
Brand A	100pcs/edge

## Cases

### Finish turning - Flange

- **Workpiece** Stainless steel SUS304
- **Machining Methods** Wet-type finish turning of continuous external & end face
- **Insert** VNMG160408-BF WS7225
- **Cutting Conditions**  $V_c=171\sim180\text{m/min}$ ,  $f=0.08\text{mm/r}$ ,  $a_p=0.10\text{mm}(Ra\leq 0.8)$



BF chip-breaker, with sharp edge, landless design, big and wide rake angle, provide small chip deformation and small cutting vibration, suitable for finish machining environment with high surface quality requirement only. WS7225 is preferable for the machining of viscous materials.

Cutting life	
Hardstone	160~180pcs/edge
Brand A	120pcs/edge

### Finish turning - Flange

- **Workpiece** Stainless steel SUS304
- **Machining Methods** Finish turning of continuous external & end face
- **Insert** WNMG080408-BF WS7225
- **Cutting Conditions**  $V_c=259\text{m/min}$ ,  $f=0.10\text{mm/r}$ ,  $a_p=0.10\text{mm}(Ra\leq 0.8)$



BF chip-breaker, with sharp edge, landless design, big and wide rake angle, provide small chip deformation and small cutting vibration, suitable for finish machining environment with high surface quality requirement only. WS7225 is preferable for high speed machining of viscous materials.

Cutting life	
Hardstone	47~48pcs/edge
Brand A	36~55pcs/edge

### Rough Turning - Compressor Cylinder

- **Workpiece** Stainless steel SUS304
- **Machining Methods** Wet-type semi-finish turning of continuous conical surface & end face
- **Insert** WNMG080408-BM WS7225
- **Cutting Conditions**  $V_c=150\sim243\text{m/min}$ ,  $f=0.2\text{mm/r}$ ,  $a_p=0.8\text{mm}$



BM chip-breaker, with sharp cutting edge and large rake angle, provide small chip deformation and small built up edge, together with the high anti-adhesion property new grade, significantly improved the lifespan.

Cutting life	
Hardstone	125pcs/edge
Brand A	73pcs/edge

### Rough turning

- **Workpiece** HT250
- **Machining Methods** Rough turning of external and end face
- **Insert** WNMG080412 WS6115
- **Cutting Conditions**  $V_c=415\text{m/min}$ ,  $f=0.15\text{mm/r}$ ,  $a_p=0.4\text{mm}$



For sub high speed turning of cast iron workpiece, its lifespan and stability reached the imported top brand level

Cutting life	
Hardstone	60~70pcs/edge
Brand A	60~70pcs/edge

Cases

Continuous and interrupted rough turning - Compressor Flange

- **Workpiece** Flange
- **Machining Methods** Dry-type rough turning of continuous external and interrupted end face
- **Insert** WNMG080408 WS6115
- **Cutting Conditions** Vc=563m/min, f=0.25mm/r, ap=1mm



For high speed turning of slight interrupted cast iron workpiece, it's lifespan and stability reached the imported top brand level.

Cutting life	
Hardstone	70~80pcs/edge
Brand A	70~80pcs/edge

Continuous rough turning - Compressor Crankshaft

- **Workpiece** Crankshaft QT550
- **Machining Methods** Continuous rough turning
- **Insert** WNMG080408 WS6115
- **Cutting Conditions** Vc=190m/min, f=0.4mm/r, ap=1mm

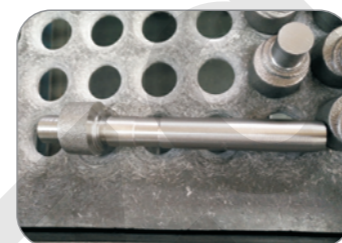

For medium and low speed turning of cast iron workpiece, it's lifespan and stability much more better than domestic brands.

Cutting life	
Hardstone	170~176pcs/edge
Brand A	120~140pcs/edge

Parting and Grooving

● Good working condition ● Normal working condition ■ Bad working condition

Shape	Description	CVD Coating				PVD Coating				un-coated	Cutting Parameters								
		WS8215	WS8135	WS8133	WS6115	WS7120	WS7140	WS5115	WS5120		WS5130	WS5225	WS5231	WS7125	WS7225	WS7130	WSK10	Ap	Fn
																		(mm)	(mm/r)
	QCMB2002-T	16	2	3.55	0.2	●	●											~14.0	0.05-0.12
	QCMB2502-T	18.5	2.5	4.5	0.2	●	●											~16.0	0.05-0.15
	QCMB3004-T	21	3	4.86	0.4	●	●											~18.0	0.07-0.15
	QCMB4004-T	21	4	4.86	0.4	●	●											~18.0	0.07-0.18
	QCMB5008-T	26	5	5.8	0.8	●	●											~23.0	0.10-0.18
	QPMB2010-M	16	2	3.5	1	●	●											~14.0	0.05-0.12
	QPMB3015-M	21	3	4.8	1.5	●	●											~18.0	0.07-0.12
	QPMB4020-M	21	4	4.8	2	●	●											~23.0	0.07-0.15
	QPMB5025-M	26	5	5.8	2.5	●	●											~23.0	0.08-0.15
	QPMB6030-M	26	6	5.9	3	●	●											~23.0	0.08-0.15
	TDC20	20	2	3.9	0.2													~22.0	0.05-0.18
	TDC30	20	3	4.2	0.2													~22.0	0.07-0.25
	TDC40	20	4	4.2	0.3													~22.0	0.08-0.30
	TDC50	25	5	5	0.3													~25.0	0.09-0.35

Cases

Parting and Grooving

- **Workpiece** Steel 45#
- **Machining way** Continuous external grooving
- **Inserts** QCMB3004-T WS7125
- **Cutting Conditions** Vc=82m/min, f=0.2mm/r

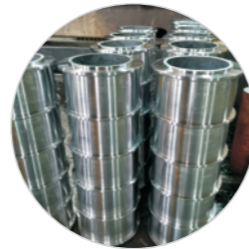

T type chip breaker, provide smooth cutting and excellent chip evacuation performance.

Cutting life	
Hardstone	60~70pcs/edge
Brand A	60pcs/edge

Grooving

- **Workpiece** piston 45#
- **Machining way** Wet-type continuous grooving
- **Inserts** QCMB4004-T WS8133
- **Cutting Conditions** Vc=325m/min, f=0.12mm/r



T type chip-breaker, smooth and light cutting, effectively reduced the vibration. special designed groove cutter grade WS8133, provide good vibration resistance,excellent wear resistance and stability.

Cutting life	
Hardstone	55~60pcs/edge
Brand A	25~30pcs/edge

Grooving

- **Workpiece** Qt600
- **Machining way** Wet-type continuous/interrupted grooving
- **Inserts** QCMB5008-T WS8133
- **Cutting Conditions** Vc=150m/min, f=0.12~0.18mm/r



T type chip breaker, smooth and light cutting, effectively reduced the vibration. special designed grade WS8133 provide good vibration resistance, excellent wear resistance and stability.

Cutting life	
Hardstone	130~140pcs/edge
Brand A	100~120pcs/edge

## 60° ISO metric thread

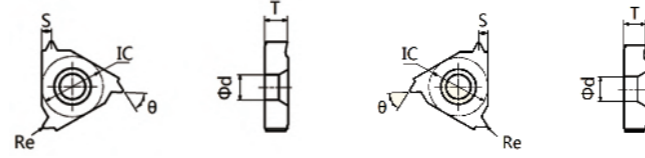

● Good working condition ● Normal working condition ■ Bad working condition

Shape	Description	Thread pitch	Specification (mm)						Grade
			IC	S	T	Re	ød	θ	
	16ER100ISO	1.00	9.53	0.70	3.52	0.13	4.00	60°	WS5225
	16ER125ISO	1.25	9.53	0.90	3.52	0.16	4.00	60°	WS5225
	16ER150ISO	1.50	9.53	1.00	3.52	0.10	4.00	60°	WS5225
	16ER175ISO	1.75	9.53	1.20	3.52	0.22	4.00	60°	WS5225
	16ER200ISO	2.00	9.53	1.30	3.52	0.26	4.00	60°	WS5225
	16ER250ISO	2.50	9.53	1.50	3.52	0.33	4.00	60°	WS5225
	16ER300ISO	3.00	9.53	1.60	3.52	0.44	4.00	60°	WS5225
	11IR100ISO	1.00	6.35	0.70	3.05	0.06	3.20	60°	WS5225
11IR125ISO	1.25	6.35	0.90	3.05	0.08	3.20	60°	WS5225	
11IR150ISO	1.50	6.35	1.00	3.05	0.10	3.20	60°	WS5225	
11IR250ISO	2.50	6.35	1.50	3.05	0.08	3.20	60°	WS5225	
	16IR100ISO	1.00	9.53	0.70	3.52	0.06	4.00	60°	WS5225
	16IR125ISO	1.25	9.53	0.90	3.52	0.08	4.00	60°	WS5225
	16IR150ISO	1.50	9.53	1.00	3.52	0.10	4.00	60°	WS5225
	16IR175ISO	1.75	9.53	1.20	3.52	0.11	4.00	60°	WS5225
	16IR200ISO	2.00	9.53	1.30	3.52	0.13	4.00	60°	WS5225
	16IR250ISO	2.50	9.53	1.50	3.52	0.17	4.00	60°	WS5225
	16IR300ISO	3.00	9.53	1.50	3.52	0.22	4.00	60°	WS5225

## 55° Whitworth thread

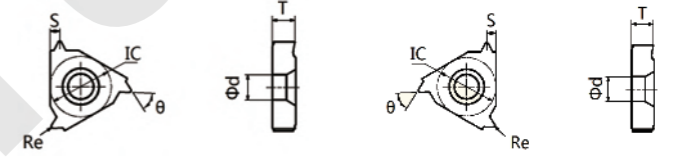

● Good working condition ● Normal working condition ■ Bad working condition

Shape	Description	Thread pitch	Specification (mm)						Grade
			IC	S	T	Re	ød	θ	
	16ER11W	11.00	9.53	1.50	3.52	0.30	4.00	55°	WS5225
	16ER14W	14.00	9.53	1.20	3.52	0.23	4.00	55°	WS5225
	16ER19W	19.00	9.53	1.00	3.52	0.17	4.00	55°	WS5225
	16IR11W	11.00	9.53	1.50	3.52	0.30	4.00	55°	WS5225
	16IR12W	12.00	9.53	1.40	3.52	0.30	4.00	55°	WS5225
	16IR14W	14.00	9.53	1.20	3.52	0.23	4.00	55°	WS5225
	16IR19W	19.00	9.53	1.00	3.52	0.17	4.00	55°	WS5225

## General pitch thread

● Good working condition ● Normal working condition ■ Bad working condition

Shape	Description	Thread pitch	Specification (mm)						Grade
			IC	S	T	Re	ød	θ	
	16ERAG55	0.5-3.0	9.53	1.70	3.52	0.06	4.00	55°	WS5225
	16ERA55	0.5-1.5	9.53	0.90	3.52	0.05	4.00	55°	WS5225
	16ERG55	1.75-3.0	9.53	1.70	3.52	0.23	4.00	55°	WS5225
	16ERAG60	0.5-3.0	9.53	1.70	3.52	0.07	4.00	60°	WS5225
	16ERA60	0.5-1.5	9.53	0.90	3.52	0.06	4.00	60°	WS5225
	16ERG60	1.75-3.0	9.53	1.70	3.52	0.18	4.00	60°	WS5225
	16IRAG55	0.5-3.0	9.53	1.70	3.52	0.06	4.00	55°	WS5225
	16IRA55	0.5-1.5	9.53	0.90	3.52	0.05	4.00	55°	WS5225
	16IRG55	1.75-3.0	9.53	1.70	3.52	0.21	4.00	55°	WS5225
	16IRAG60	0.5-3.0	9.53	1.70	3.52	0.08	4.00	60°	WS5225
	16IRA60	0.5-1.5	9.53	0.90	3.52	0.05	4.00	60°	WS5225
	16IRG60	1.75-3.0	9.53	1.70	3.52	0.10	4.00	60°	WS5225



British standard taper pipe thread

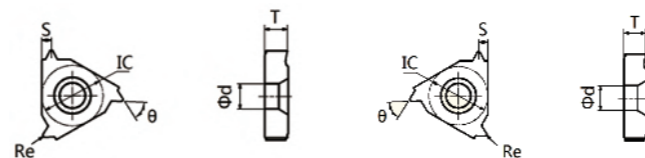

● Good working condition ● Normal working condition ❏ Bad working condition

Shape	Description	Thread pitch	Specification (mm)						Grade
			IC	S	T	Re	ød	θ	
									WS5225
	16ER11BSPT	11.00	9.53	1.50	3.52	0.32	4.00	55°	●
	16ER14BSPT	14.00	9.53	1.20	3.52	0.23	4.00	55°	●
	16ER19BSPT	19.00	9.53	0.90	3.52	0.19	4.00	55°	●
	16IR11BSPT	11.00	9.53	1.50	3.52	0.32	4.00	55°	●
	16IR14BSPT	14.00	9.53	1.20	3.52	0.23	4.00	55°	●
	16IR19BSPT	19.00	9.53	0.90	3.52	0.19	4.00	55°	●

American standard taper pipe thread

● Good working condition ● Normal working condition ❏ Bad working condition

Shape	Description	Thread pitch	Specification (mm)						Grade
			IC	S	T	Re	ød	θ	
									WS5225
	16ER14NPT	14.00	9.53	1.20	3.52	0.07	4.00	60°	●
	16ER115NPT	11.50	9.53	1.50	3.52	0.08	4.00	60°	●
	16ER18NPT	18.00	9.53	1.00	3.52	0.06	4.00	60°	●
	16IR14NPT	14.00	9.53	1.20	3.52	0.07	4.00	60°	●
	16IR115NPT	11.50	9.53	1.50	3.52	0.08	4.00	60°	●
	16IR18NPT	18.00	9.53	1.00	3.52	0.06	4.00	60°	●

Drilling

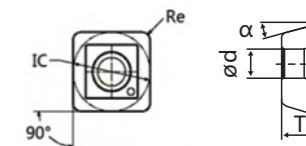

● Good working condition ● Normal working condition ❏ Bad working condition

Shape	Description	Specification (mm)						CVD Coating			PVD Coating			un-coated	Cutting Parameters											
		IC	T	r	ød	α	WS8215	WS8135	WS8133	WS6115	WS7120	WS7140	WS5115		WS5120	WS5130	WS5225	WS5231	WS7125	WS7225	WS7130	WSK10	Ap	Fn		
								(mm)	(mm/r)																	
	SPMG050204DG	11.5	4.3	0.8	4.5	16.5°	●																		0.04-0.15	
	SPMG060204DG	9.8	4.3	0.8	4.05	17.5°	●																			0.04-0.16
	SPMG07T308DG	7.94	3.97	0.8	2.85	15.5°	●																			0.04-0.20
	SPMG090408DG	6	2.38	0.4	2.61	14°	●																			0.06-0.25
	SPMG110408DG	5	2.38	0.4	2.25	14°	●																			0.06-0.28

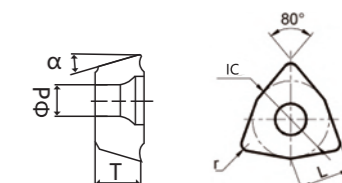

● Good working condition ● Normal working condition ❏ Bad working condition

Shape	Description	Specification (mm)						CVD Coating			PVD Coating			un-coated	Cutting Parameters											
		IC	T	r	ød	α	WS8215	WS8135	WS8133	WS6115	WS7120	WS7140	WS5115		WS5120	WS5130	WS5225	WS5231	WS7125	WS7225	WS7130	WSK10	Ap	Fn		
								(mm)	(mm/r)																	
	WCMX030204	5.56	2.38	0.8	2.8	7	●																			0.04-0.15
	WCMX030208	5.56	2.38	0.8	2.8	7	●																			0.04-0.15
	WCMX040204	6.35	2.38	0.8	3	7	●																			0.04-0.16
	WCMX040208	6.35	2.38	0.8	3	7	●																			0.04-0.16
	WCMX050308	7.94	3.18	0.8	3.4	7	●																			0.04-0.20
	WCMX06T308	9.525	3.97	0.8	3.8	7	●																			0.06-0.25
	WCMX080412	12.7	4.76	1.2	4.4	7	●																			0.06-0.28

### The introduction of Grade

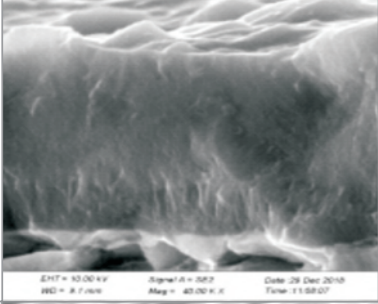
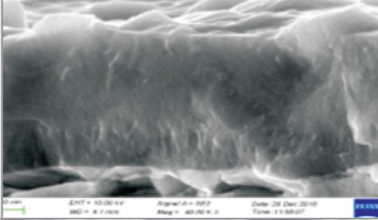
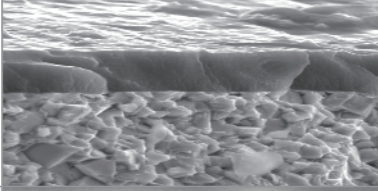
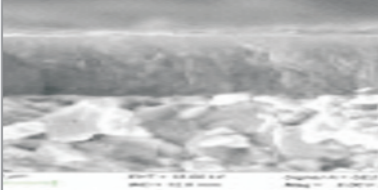
Grade	Coating				Coating structure	Application	ISO	Wear Resistance ← Toughness															
	Type	Color	Metallographic Structure	Composition				01	05	10	15	20	25	30	35	40	45						
WS5115	PVD	Purple Bronze		TiAlN+CrAlN +TiSiN	Evenly distributed sub-micro level WC crystal grain with high strength and reasonable adjusted alloy composition, enhanced the solution of binder phase, which ensured the high toughness of the substrate; It has a multi-layer composite coating, TiAlN bottom layer increases the binding force with substrate, AlCrN functional layer provide superior high temperature performance, TiSiN surface layer reduces frictional coefficient to workpiece; The coating match the elastic modulus with the substrate and firmly integrated.	Extremely suitable for the milling of hardened steel, especially for steel with hardness range HRC45-HRC62, which excellent in performance.	P15-P30 M15-M30 K15-K30																
WS5120	PVD	Purple Bronze		TiAlN+CrAlN +TiSiN	Special substrate with better wear resistance and toughness, suitable for high hardness material milling. Matching with latest diversified nano coating to provide better high temperature hardness, excellent in performance for high hardness material processing, It's comprehensive performance can be in the leading level for hard material milling applications.	It is used for general milling of steel, stainless steel, cast iron and other materials, especially for steel with hardness range HRC30-HRC50, which excellent in performance.	P20-P30 M20-M30 K20-K30																
WS5130	PVD	Gray		AlTiN	Newly developed substrate, dedicated for die milling cutter, it's ultra fine particles and special ratio greatly improves the wear resistance and toughness of the substrate, and reduces the risk of edge collapse. Match up latest nano coating, it's comprehensive performance can be top No.1 in segmented application field.	It is used for general milling of steel, stainless steel, cast iron and other materials, especially for steel with hardness range HRC30-HRC50, which excellent in performance.	P20-P35 M20-M35 K20-K35																
WS7130	PVD	Gray		AlTiN	Specially used for machining of difficult-to-cut materials, with high hardness, high temperature resistance and oxidation resistance. The proprietary coating can still maintain high hardness when temperature reach 1100°C, and protect the cutter substrate from oxidation. Can be used for high speed cutting.	Preferred grade for stainless steel milling, match with different grooves, it can meet rough/finish milling requirement of all kinds of stainless steel and titanium alloy material, with good stability and safety property.	P35-P45 M34-M45																

E

Turning

Grooving

Threading

Drilling

Milling

### Insert Identification System

			<b>B</b>	With	Without		<b>N</b>	Without	Without	
			<b>H</b>	With	Single-Side		<b>R</b>	Without	Single-Side	
			<b>C</b>	With	Without		<b>F</b>	Without	Double-Side	
			<b>J</b>	With	Double-side		<b>A</b>	With	Without	
			<b>W</b>	With	Without		<b>M</b>	With	Single-Side	
		<b>Others</b>	<b>T</b>	With	Single-Side		<b>G</b>	With	Double-Side	
			<b>Q</b>	With	Without		<b>X</b>	---	---	Special
			<b>U</b>	With	Double-side					
<b>Insert Shape</b>			<b>Chip-breaker and Clamping system</b>							
			Code	Hole	Chip-breaker	Section Plane	Code	Hole	Chip-breaker	Section Plane

**A P M T**

Clearance angle of main cutting edge		Tolerance (mm)																									
Code	Clearance angle	Code	Clearance angle	Nose height Tolerance(m)		Inscribed circle(ΦD)		Thickness Tolerance(s)		♦M-level tolerance(Identified by shape)																	
A	3°	B	5°	Code		Code		Code		♦Tolerance of tool tip height (mm)																	
C	7°	D	15°	A	±0.005	F	±0.005	C	±0.013	H	±0.013	E	±0.025	G	±0.025	J	±0.005	K	±0.013	L	±0.025	M	±0.08±0.18	N	±0.08±0.18	U	±0.13±0.38
E	20°	F	25°	F	±0.005	C	±0.013	H	±0.013	E	±0.025	G	±0.025	J	±0.005	K	±0.013	L	±0.025	M	±0.08±0.18	N	±0.08±0.18	U	±0.13±0.38		
G	30°	N	40°	C	±0.013	H	±0.013	E	±0.025	G	±0.025	J	±0.005	K	±0.013	L	±0.025	M	±0.08±0.18	N	±0.08±0.18	U	±0.13±0.38				
P	11°	O	Others	F	±0.005	C	±0.013	H	±0.013	E	±0.025	G	±0.025	J	±0.005	K	±0.013	L	±0.025	M	±0.08±0.18	N	±0.08±0.18	U	±0.13±0.38		
				F	±0.005	C	±0.013	H	±0.013	E	±0.025	G	±0.025	J	±0.005	K	±0.013	L	±0.025	M	±0.08±0.18	N	±0.08±0.18	U	±0.13±0.38		
				F	±0.005	C	±0.013	H	±0.013	E	±0.025	G	±0.025	J	±0.005	K	±0.013	L	±0.025	M	±0.08±0.18	N	±0.08±0.18	U	±0.13±0.38		
				F	±0.005	C	±0.013	H	±0.013	E	±0.025	G	±0.025	J	±0.005	K	±0.013	L	±0.025	M	±0.08±0.18	N	±0.08±0.18	U	±0.13±0.38		
				F	±0.005	C	±0.013	H	±0.013	E	±0.025	G	±0.025	J	±0.005	K	±0.013	L	±0.025	M	±0.08±0.18	N	±0.08±0.18	U	±0.13±0.38		
				F	±0.005	C	±0.013	H	±0.013	E	±0.025	G	±0.025	J	±0.005	K	±0.013	L	±0.025	M	±0.08±0.18	N	±0.08±0.18	U	±0.13±0.38		
				F	±0.005	C	±0.013	H	±0.013	E	±0.025	G	±0.025	J	±0.005	K	±0.013	L	±0.025	M	±0.08±0.18	N	±0.08±0.18	U	±0.13±0.38		
				F	±0.005	C	±0.013	H	±0.013	E	±0.025	G	±0.025	J	±0.005	K	±0.013	L	±0.025	M	±0.08±0.18	N	±0.08±0.18	U	±0.13±0.38		
				F	±0.005	C	±0.013	H	±0.013	E	±0.025	G	±0.025	J	±0.005	K	±0.013	L	±0.025	M	±0.08±0.18	N	±0.08±0.18	U	±0.13±0.38		
				F	±0.005	C	±0.013	H	±0.013	E	±0.025	G	±0.025	J	±0.005	K	±0.013	L	±0.025	M	±0.08±0.18	N	±0.08±0.18	U	±0.13±0.38		

32.00			32															12	12.70
31.75			31															10	11.11
25.40			25	25														T9	9.72
25.00	25	25	25															09	9.52
20.00			20															07	7.94
19.05	19		19	19	33													T6	6.75
16.00		19	16															06	6.35
15.875	16		15	16	27													T5	5.95
12.70	12	15	12	12	22	22	08											05	5.56
12.00			12															T4	4.96
10.00			10															04	4.76
9.525	09	11	09	19	16	16	06	16										T3	3.97
8.00			08															03	3.18
6.35	06	07			11	11												T2	2.58
6.00			06															02	2.38
5.56								09										T1	1.98
5.50				05														01	1.59
3.97								06										T0	0.99
																		00	0.79
Diameter of IC(mm)	C	D	R	S	T	V	W	K	Insert Shape		Code		Thickness(mm)						

**16 05 PD E R - HM**

Wiper	
A	45°
D	60°
E	75°
F	85°
P	90°
Z	Others

Chamfer	
F	0-5°
E	1-10°
T	2-15°
S	3-20°
	4-25°
	5-30°
	1-10°
	1-10°

Chip-breaker Code	
F	0-0.10
E	1-0.15
T	2-0.20
S	3-0.25
	4-0.30
	5-0.35
	6-0.40
	7-0.45

Cutting Direction	
R	Right
L	Left
N	Double side

Overview

● Square shoulder milling



● Profile milling



● Helical end milling



● Face milling

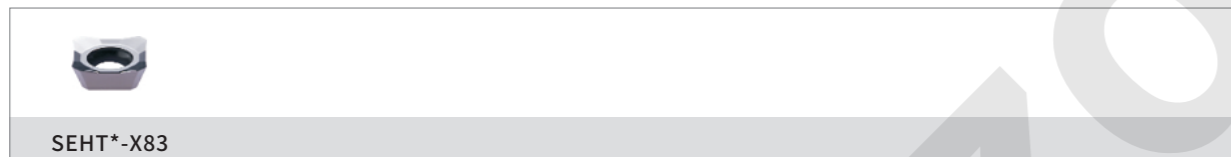

● Economical square shoulder milling



High Precision Square Shoulder Milling Insert S/CSM190

- New**
- ✓ Long service life
  - ✓ High cutting efficiency
  - ✓ High surface finish quality
  - ✓ High vertical sidewall accuracy



Features

90 degree shoulder square milling in the true sense

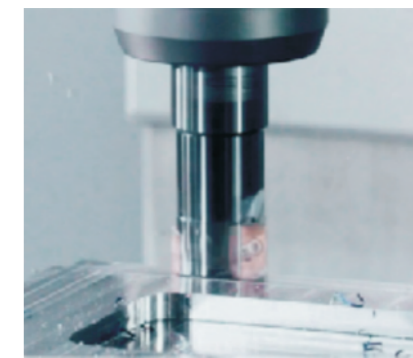

Excellent sidewall surface finish, runout <math>< 0.005\text{mm}</math> (depth: 20mm,  $\phi 16 \times 2$  edges,)

Features A

The unique inserts design of 3D chipbreaker and cutting edge structure to reduce cutting vibration.

The small cutting wedge angle enables the tool to smoothly cut into the workpiece, and under the control of the inserts edge structure, it can especially achieve high-precision sidewall surface quality. At the same time, with the help of the anti-vibration cutter body, the cutting vibration can be better reduced.

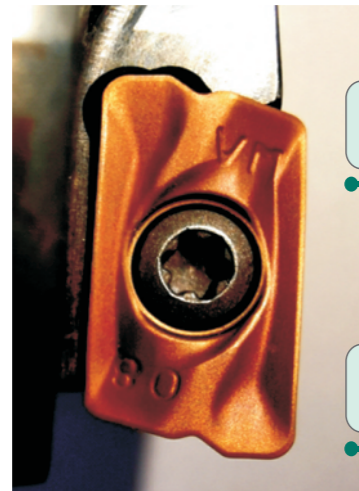

Positive axial rake angle

Optimal cutting edge shape



### Features B

Latest independently-developed three PVD coating types for your choice, covering various materials and hardness range.

Machined material hardness  
Under HRC30  
**<WS5130>**

Machined material hardness  
HRC30~HRC40  
**<WS5120>**

Machined material hardness  
HRC40~HRC50  
**<WS5115>**

Suitable for general purpose machining of steel, stainless steel and cast iron workpiece, as well as high hardness materials like SKD61, hardened steel, etc.

### Features C

Special pre- and post-coating technology and micro edge processing technologies. Fine and smooth surface, uniform cutting edge, greatly increased the cutting stability.

### Features D

Apart from the high strength steel body, a new combination of exchangeable tool head and cemented carbide holder has been adopted, which enriched the tool style and enhanced the vibration resistance of sidewall machining.

**Highly Recommended**

- Ensure sidewall accuracy  
Precision edge control
- Effective torque transfer  
High precision thread connection
- Resist cutting vibration  
Cemented carbide holder

### Cutting performance

Sidewall precision comparison



	HARDSTONE	Brand M	Brand S
NO.1 (ap=2mm)	0.002mm	0.002mm	0.002mm
NO.2 (ap=4mm)	0.004mm	0.007mm	0.005mm

HARDSTONE sample's average precision runout <0.005mm, better than other brand samples.

Workpiece materials: steel 45 # (28HRC)  
 ■ Cutting parameters:  
 Vc=280m/min, fz=0.15mm/z, ap=20mm, ae=1mm  
 ■ Tool type:  
 AOKT113508PEER-VM, WS5130, tooth φ16x2, overhang depth: 40mm

Plane precision comparison



	HARDSTONE	Brand M	Brand S
Vertical toolpath	Ra=0.31μm	Ra=0.37μm	Ra=0.38μm
Parallel toolpath	Ra=0.26μm	Ra=0.32μm	Ra=0.37μm

For the vertical precision and parallel toolpath precision, HARDSTONE products are much higher than other samples.

Workpiece materials: steel 45 # (28HRC)  
 ■ Cutting parameters:  
 Vc=280m/min, fz=0.15mm/z, ap=20mm, ae=1mm  
 ■ Tool type:  
 AOKT113508PEER-VM, WS5130, tooth φ16x2, overhang depth: 40mm

## New generation economic square shoulder milling insert S/CSM390

### Service life comparison



long lifespan

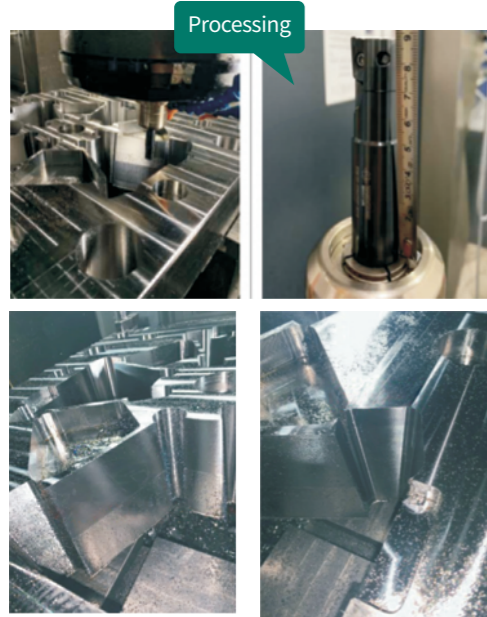
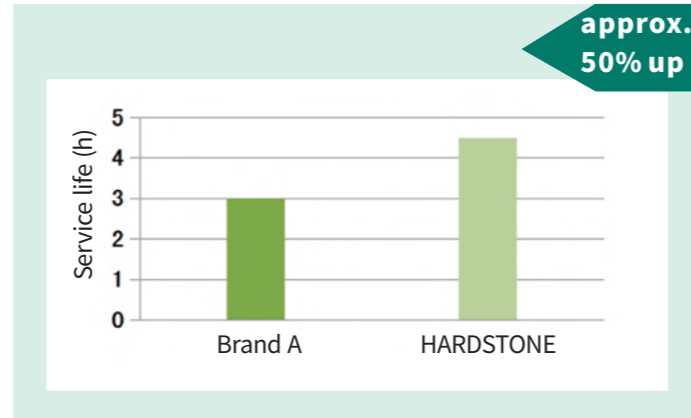

Processing

Workpiece material: 718H (35HRC)  
 Test location: Mould center, Xiamen City  
 Workpiece: large-scale mould base cavity  
 Cutting parameters:  
 $V_c=326\text{m/min}$ ,  $f_z=0.5\text{mm/z}$ ,  $a_p=0.25\text{mm}$ ,  $a_e=0.1\text{mm}$   
 Tool: AOKT160408PEER-VM, WS5130,  
 Tool  $\phi 26 \times 2$ , Overhang depth: 80mm

HARDSOTNE equivalent quality Brand A

ZNMU0403\*PNR-\*\*

ZNMU0806\*PNR-\*\*

SSM390\*\*\*(Shank)

CSM390\*\* (Cutter)

### Features

- Optimized support surface structure provide good support and excellent chip-breaking capacity.
- Independent support, surface to avoid chip contamination
- Stable positioning desgin, suppressed the micro-vibration and improves the lifespan.
- Large rake angle, low resistance design, enhanced large cutting edge, excellent versatility.
- Hyperbolic edge desgin, compensate the errors of manufacturing and clamping process, take account of both square shoulder effect and surface quality.

## New generation economic square shoulder milling insert S/CSM390

### Cutting effect

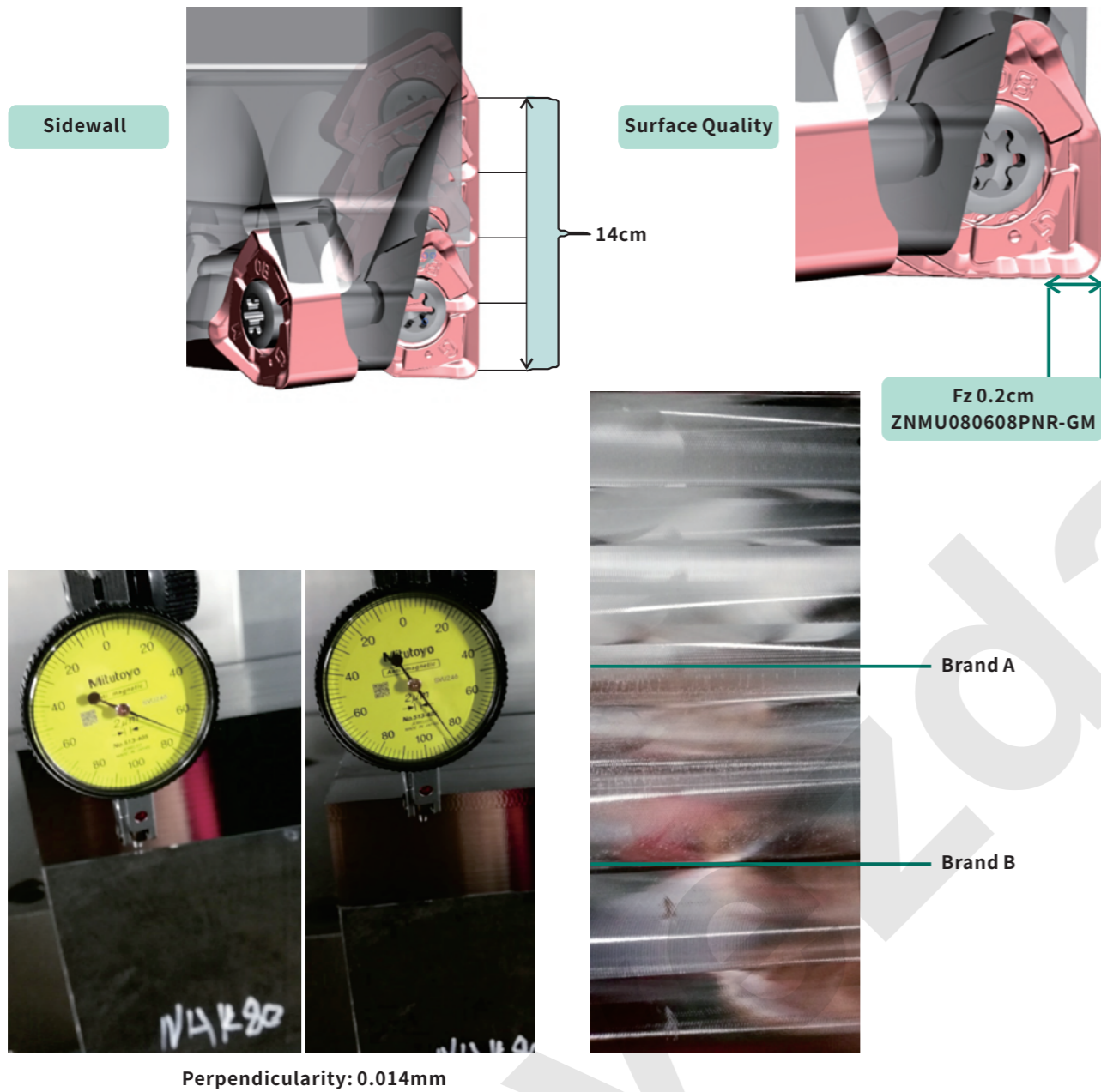

### Application and parameters

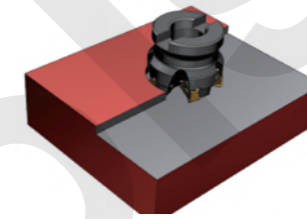

Face milling

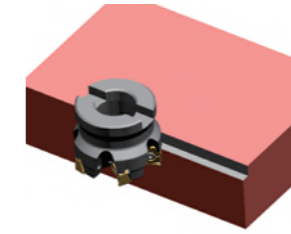

Square shoulder milling

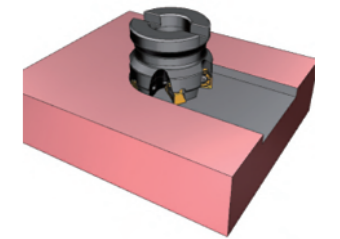

Slot milling

ISO	Material	Grade	Recommended cutting parameters	
			VC( m/min)	FZ(mm/z)
P	Mild steel	WS5130 WS5120	120~250	0.08~0.3
	Carbon steel alloy steel		120~200	0.08~0.3
	Pre hardened steel		120~200	0.08~0.3
M	Martensitic stainless steel		120~180	0.08~0.3
	Austenitic stainless steel		120~160	0.08~0.3
K	Grey cast iron		100~220	0.08~0.3
	Nodular cast iron	100~180	0.08~0.3	
S	Heat resistant alloy	50~100	0.08~0.3	

**Square shoulder milling**

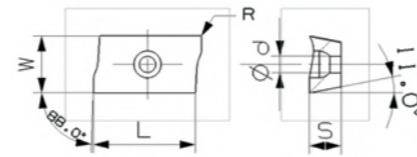

● Good working condition ● Normal working condition ❏ Bad working condition

Shape	Description	L	W	S	φd	R	Coating										Cutting Parameters										
							CVD Coating					PVD Coating					un-coated	Ap	Fn								
							WS8215	WS8135	WS8133	WS6115	WS7120	WS7140	WS5115	WS5120	WS5130	WS5225	WS5231	WS7125	WS7130	WSK10	(mm)	(mm/r)					
	AOKT113504PEER-VM	11.75	6.42	3.50	2.80	0.40												●	●	●			0.1~3.0	0.10-0.40			
	AOKT113508PEER-VM	11.75	6.42	3.50	2.80	0.80													●	●	●			0.1~3.0	0.10-0.60		
	AOKT113516PEER-VM	11.75	6.42	3.50	2.80	1.60													●	●	●			0.1~3.0	0.10-1.00		
	AOKT160408PEER-VM	17.65	9.64	4.76	4.40	0.80													●	●	●			0.1~5.0	0.10-0.60		
	AOKT160412PEER-VM	17.65	9.64	4.76	4.40	1.20													●	●	●			0.1~5.0	0.10-1.00		
	APMT1135PDER-HM	11.25	6.20	3.50	2.80	0.80													●	●	●			0.1~3.0	0.10-0.80		
	APMT113516PDER-HM	11.25	6.20	3.50	2.80	1.60													●	●	●			0.1~3.0	0.10-1.00		
	APMT1605PDER-HM	17.25	9.25	4.76	4.40	0.80													●	●	●			0.1~5.0	0.10-1.00		
	APMT160520PDER-HM	17.25	9.25	4.76	4.40	2.00													●	●	●			0.1~5.0	0.10-1.20		
	APMT150412-MM	16.33	12.70	4.76	5.40	1.20													●	●				~16.33	0.05-0.15		
	APHX1504	16.33	12.70	4.76	5.40	0.40													●	●				~16.33	0.05-0.15		
	APGT1135PDFR-G2	11.25	6.20	3.50	2.80	0.80																		●	0.1~3.0	0.10-0.15	
	APGT1604PDFR-G2	17.25	9.33	5.20	4.40	0.80																			●	0.1~5.0	0.10-0.20
	APKT1604PDFR-MA	16.17	9.53	4.76	4.40	0.20																			●	0.1~5.0	0.05-0.15
	APKT1604PDFR-MA3	16.17	9.53	4.76	4.40	0.80																			●	0.1~5.0	0.10-0.20

**Profile milling**



● Good working condition ● Normal working condition ❏ Bad working condition

Shape	Description	L1	α	D1	D2	T	Coating										Cutting Parameters										
							CVD Coating					PVD Coating					un-coated	Ap	Fn								
							WS8215	WS8135	WS8133	WS6115	WS7120	WS7140	WS5115	WS5120	WS5130	WS5225	WS5231	WS7125	WS7225	WS7130	WSK10	(mm)	(mm/r)				
	RCKT10T3MO-FM		7°	10.00	4.40	3.97														●	●	●			0.1~2.0	0.20-0.80	
	RCKT1204MO-FM		7°	12.00	4.40	4.76															●	●	●			0.2~3.0	0.25-1.00
	RCKT1606MO-FM		7°	16.00	5.50	6.35															●	●	●			0.5~4.0	0.30-1.20
	RCKT1606MO-MS		7°	16.00	5.50	6.35															❏			❏		0.5~4.0	0.30-1.20
	RCKT2006MO-FM		7°	20.00	6.55	6.35															●	●	●			0.5~6.0	0.40-1.20
	RDMW1003MO-FM		15°	10.00	4.40	3.18																●				0.1~0.5	0.20-0.80
	RDMW12T3MO-FM		15°	12.00	4.40	3.97																				0.2~1.0	0.30-1.00
	RDMW10T3MO		15°	10.00	4.50	3.97															●	●				0.1~0.5	0.30-1.00
	RDMW1204MO		15°	12.00	4.40	3.97															●	●				0.2~1.0	0.30-1.00
	RDMW1605MO		15°	16.00	5.50	5.56															●	●				0.5~2.0	0.50-1.50
	RPKT10T3MO-MS		11°	10.00	4.50	3.97															❏			❏		0.1~2.0	0.20-0.80
	RPKT1204MO-MS		11°	12.00	4.00	4.76															❏			❏		0.2~3.0	0.25-1.00
	RPMW1003MO		11°	10.00	4.50	3.18															●	●	●			0.1~0.5	0.20-0.80
	RPMT1204MO-HM		11°	12.00	5.50	4.76															●	●	●			0.2~2.0	0.30-0.80

**Helical end milling**

● Good working condition ● Normal working condition ❏ Bad working condition

Shape	Description	Dimensions					Coating										Cutting Parameters												
		L	φD	S	φd	R	CVD Coating					PVD Coating					un-coated	Ap	Fn										
		(mm)	(mm)	(mm)	(mm)	(mm)	WS8215	WS8135	WS8133	WS6115	WS7120	WS7140	WS5115	WS5120	WS5130	WS5225	WS5231	WS7125	WS7225	WS7130	WSK10	(mm)	(mm/r)						
	SPHX120408T21	12.70	12.70	4.76	5.50	0.80																				●	●	~11.5	0.05-0.15
	SPMT120408-MM	12.70	12.70	4.76	5.50	0.80																				●	●	~11.5	0.05-0.15



**Face milling**

● Good working condition ● Normal working condition ■ Bad working condition

Shape	Description	Diagram				CVD Coating		PVD Coating		un-coated	Cutting Parameters												
		L	φD	S	φd	WS8215	WS8135	WS8133	WS6115		WS7120	WS7140	WS5115	WS5120	WS5130	WS5225	WS5231	WS7125	WS7225	WS7130	WSK10	Ap	Fn
																						(mm)	(mm/r)
	SEHT1204AFFN-X83	12.70	12.70	4.76	5.50															●	~4.0	0.03~0.30	

**Economical square shoulder milling**

● Good working condition ● Normal working condition ■ Bad working condition

Shape	Description	Diagram					CVD Coating		PVD Coating		un-coated	Cutting Parameters													
		IC	A <sub>pmax</sub>	R	φd	T	WS8215	WS8135	WS8133	WS6115		WS7120	WS7140	WS5115	WS5120	WS5130	WS5225	WS5231	WS7125	WS7225	WS7130	WSK10	Ap	Fn	
																							(mm)	(mm/r)	
	ZNMU040308PNR-GM	7	4.2	0.8	2.8	3.65																●	~4.2	0.05~0.30	
	ZNMU080608PNR-GM	12	7.2	0.8	4.6	6.35																	●	~7.3	0.06~0.35
	ZNMU080608PNR-GL	12	7.2	0.8	4.6	6.35																	●	~7.3	0.05~0.30

**Milling Tools**

**Cutter**

High strength tool body





Type	Stock	Number of teeth	Basic dimensions									Applicable inserts	Spare parts	
			φDc	Lf	φDb	φd	φd1	a	b	l	Screw		Wrench	
														AOKT1135**
CSM190-040A1605-AO11	●	5	40	40	33	16	14	8.4	5.6	18	AOKT1135**			
CSM190-050A2206-AO11	●	6	50	40	47	22	18.2	10.4	6.3	22	PEER-VM	M2.5X5.5	T-8	
CSM190-063A2207-AO11	●	7	63	40	47	22	18.2	10.4	6.3	22				
CSM190-050A2204-AO16	●	4	50	40	47	22	18.2	10.4	6.3	22	AOKT1604**			
CSM190-063A2205-AO16	●	5	63	40	47	22	18.2	10.4	6.3	22	PEER-VM	M4.0X10	T-15	
CSM190-080A2706-AO16	●	6	80	50	52	27	18.2	12.4	7	24				

Milling Tools

Shank

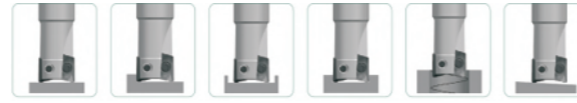
High strength tool body





Type	Stock	Number of teeth	Basic dimensions				Applicable inserts	Spare parts	
			φDc	l2	L	φDs		Screw	Wrench
									
SSM190-016G1602(L)-AO11	•	2	16	40	130(160)	16	AOKT1135** PEER-VM	M2.5X5.5	T-8
SSM190-017G1602(L)-AO11	•	2	17	40	160(200)	16			
SSM190-020G2002(L)-AO11	•	2	20	40	130(160)	20			
SSM190-021G2002(L)-AO11	•	2	21	50	160(200)	20			
SSM190-025G2503(L)-AO11	•	3	25	50	120(160)	25			
SSM190-025G2502(L)-AO16	•	2	25	50	160(200)	25	AOKT1604** PEER-VM	M4.0X10	T-15
SSM190-026G2502(L)-AO16	•	2	26	50	160(200)	25			
SSM190-032G3202(L)-AO16	•	2	32	80	160(200)	32			

Modular cutting head

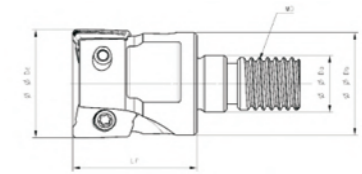
High strength tool body



Type	Stock	Number of teeth	Basic dimensions					Applicable inserts	Spare parts	
			φDc	Lf	φDa	φDb	MD		Screw	Wrench
										
KH-1702-AOKT11-M08	•	2	17	25	8.5	15	M8	AOKT1135** PEER-VM	M2.5X5.5	T-8
KH-2102-AOKT11-M10	•	2	21	30	10.5	19	M10			
KH-2603-AOKT11-M12	•	3	26	35	12.5	24	M12			
KH-3304-AOKT11-M16	•	4	33	40	17	30	M16			

Milling Tools

Shank

High strength tool body



Type	Stock	Number of teeth	Basic dimensions				Apmax	Applicable inserts	inner-cooling	Spare parts	
			D	d	L	L1				Screw	Wrench
SSM390-020G2002L-ZN04	•	2	20	20	150	30	4.2	•	ZNMU0403**	M2.5X6.5	T-8
SSM390-020G2003L-ZN04		3	20	20	150	30	4.2	•			
SSM390-021G2002L-ZN04	•	2	21	20	150	30	4.2	•			
SSM390-021G2003L-ZN04		3	21	20	150	30	4.2	•			
SSM390-025G2502L-ZN04	•	2	25	25	170	30	4.2	•			
SSM390-025G2503L-ZN04	•	3	25	25	170	30	4.2	•			
SSM390-025G2504L-ZN04		4	25	25	170	30	4.2	•			
SSM390-025G2505L-ZN04		5	25	25	170	30	4.2	•			
SSM390-026G2502L-ZN04	•	2	26	25	170	30	4.2	•			
SSM390-026G2503L-ZN04		3	26	25	170	30	4.2	•			
SSM390-032G3202L-ZN04	•	2	32	32	200	30	4.2	•			
SSM390-032G3203L-ZN04	•	3	32	32	200	30	4.2	•			
SSM390-032G3204L-ZN04		4	32	32	200	30	4.2	•			
SSM390-032G3205L-ZN04		5	32	32	200	30	4.2	•			
SSM390-032G3206L-ZN04		6	32	32	200	30	4.2	•			
SSM390-035G3202L-ZN04	•	2	35	32	200	30	4.2	•			
SSM390-035G3203L-ZN04	•	3	35	32	200	30	4.2	•			
SSM390-040G3204L-ZN04		4	40	32	200	30	4.2	•			
SSM390-040G3205L-ZN04		5	40	32	200	30	4.2	•			
SSM390-040G3206L-ZN04		6	40	32	200	30	4.2	•			

Shank

High strength tool

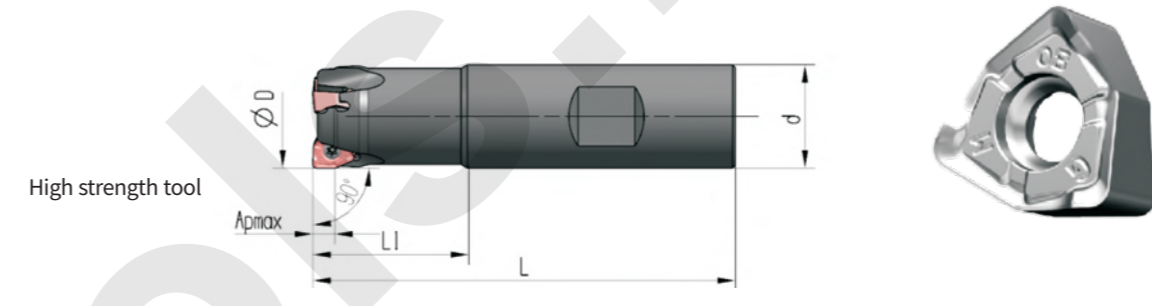

Type	Stock	Number of teeth	Basic dimensions				Apmax	Applicable inserts	inner-cooling	Spare parts	
			D	d	L	L1				Screw	Wrench
SSM390-020X2002-ZN04		2	20	20	90	30	4.2	•	ZNMU0403**	M2.5X6.5	T-8
SSM390-020X2003-ZN04		3	20	20	90	30	4.2	•			
SSM390-025X2502-ZN04		2	25	25	100	30	4.2	•			
SSM390-025X2503-ZN04		3	25	25	100	30	4.2	•			
SSM390-025X2504-ZN04		4	25	25	100	30	4.2	•			
SSM390-025X2505-ZN04		5	25	25	100	30	4.2	•			
SSM390-032X3202-ZN04		2	32	32	110	30	4.2	•			
SSM390-032X3203-ZN04		3	32	32	110	30	4.2	•			
SSM390-032X3204-ZN04		4	32	32	110	30	4.2	•			
SSM390-032X3205-ZN04		5	32	32	110	30	4.2	•			
SSM390-032X3206-ZN04		6	32	32	110	30	4.2	•			

E

Turning

Grooving

Threading

Drilling

Milling

Milling Tools

Modular cutting head

High strength tool body

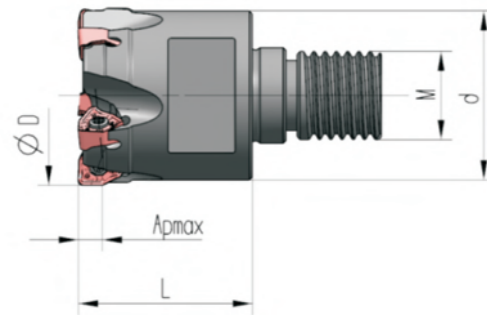

Type	Stock	Number of teeth	Basic dimensions				Apmax	Applicable inserts	inner-cooling	Spare parts	
			D	d	L	M				Screw	Wrench
KH-2002-ZN04-M10		2	20	18	30	10	4.2	ZNMU0403**	M2.5X6.5	T-8	
KH-2003-ZN04-M10		3	20	18	30	10	4.2				
KH-2502-ZN04-M12		2	25	23	30	12	4.2				
KH-2503-ZN04-M12		3	25	23	30	12	4.2				
KH-2504-ZN04-M12		4	25	23	30	12	4.2				
KH-2505-ZN04-M12		5	25	23	30	12	4.2				
KH-3202-ZN04-M16		2	32	30	40	16	4.2				
KH-3203-ZN04-M16		3	32	30	40	16	4.2				
KH-3204-ZN04-M16		4	32	30	40	16	4.2				
KH-3205-ZN04-M16		5	32	30	40	16	4.2				
KH-3206-ZN04-M16		6	32	30	40	16	4.2				

Cutter

High strength tool body

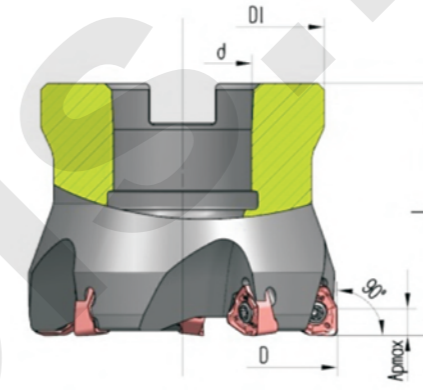

Type	Stock	Number of teeth	Basic dimensions				Apmax	Applicable inserts	inner-cooling	Spare parts	
			D	d	D1	L				Screw	Wrench
CSM390-040A1605-ZN04		5	40	16	35	40	4.2	ZNMU0403**	M2.5X6.5	T-8	
CSM390-040A1607-ZN04		7	40	16	35	40	4.2				
CSM390-050A2206-ZN04		6	50	22	45	40	4.2				
CSM390-050A2208-ZN04		8	50	22	45	40	4.2				
CSM390-063A2207-ZN04		7	63	22	50	40	4.2				
CSM390-063A2210-ZN04		9	63	22	50	40	4.2				

Milling Tools

Cutter

High strength tool body

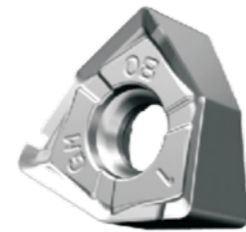
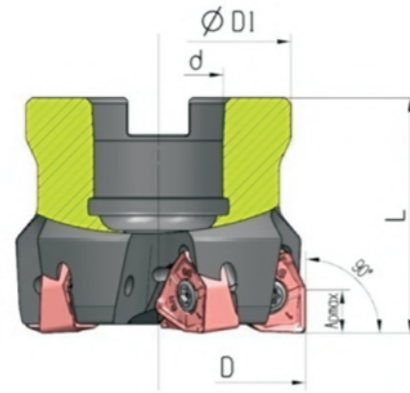

Type	Stock	Number of teeth	Basic dimensions				Apmax	Applicable inserts	inner-cooling	Spare parts	
			D	d	D1	L				Screw	Wrench
CSM390-040A1604-ZN08		4	40	16	35	40	7.3				
CSM390-050A2204-ZN08	•	4	50	22	45	40	7.3	•			
CSM390-050A2205-ZN08		5	50	22	45	40	7.3	•			
CSM390-063A2205-ZN08	•	5	63	22	50	40	7.3	•			
CSM390-063A2206-ZN08		6	63	22	50	40	7.3	•			
CSM390-080A2706-ZN08	•	6	80	27	60	50	7.3	•			
CSM390-080A2707-ZN08		7	80	27	60	50	7.3	•			
CSM390-080A2709-ZN08		9	80	27	60	50	7.3	•			
CSM390-100B3207-ZN08	•	7	100	32	80	50	7.3				
CSM390-100B3208-ZN08		8	100	32	80	50	7.3		ZNMU0806**	M4X10	T-15
CSM390-100B3211-ZN08		11	100	32	80	50	7.3				
CSM390-125B4008-ZN08	•	8	125	40	100	63	7.3				
CSM390-125B4011-ZN08		11	125	40	100	63	7.3				
CSM390-125B4014-ZN08		14	125	40	100	63	7.3				
CSM390-160C4010-ZN08		10	160	40	115	63	7.3				
CSM390-160C4012-ZN08		12	160	40	115	63	7.3				
CSM390-160C4016-ZN08		16	160	40	115	63	7.3				
CSM390-200C6012-ZN08		12	200	60	150	63	7.3				
CSM390-200C6016-ZN08		16	200	60	150	63	7.3				

Cases

Milling

- Workpiece: Mould base, 45# steel
- Machining Methods: Finish milling of mould sidewall (aire cooling)
- Insert: AOKT113508PEER-VM WS5115
- Tool: SSM190-025G2503-AO11
- Cutting parameters: Vc=220m/min, ap=2mm, ae=0.2mm, fz=0.3mm/z
- Cutting performance: Process quality, dimation precision and lifespan close to top brand.

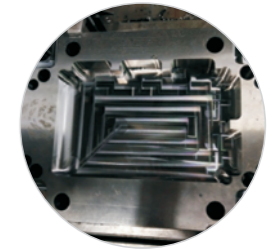

AOKT's cutting vibration is very small, significantly improved the sidewall machined trace, surface quality and surface accuracy. It's surface quality, dimension accuracy and wear resistance have reached the import level.

Finish milling - Mould Sidewall

- Workpiece: Die materialP20
- Machining Methods: Finish milling of mould sidewall
- Insert: AOKT113508PEER-VM
- Tool: KH-2603-AOKT11-M12
- Cutting parameters: Vc=259m/min, ap=1mm, ae=0.12mm, fz=0.25mm/z
- Cutting performance: Surface roughness Ra:0.63、perpendicularity < 0.01, satisfy customers' requirement!



## Cases

## Finish milling - Mould Sidewall

- **Workpiece** Mold frame 45# steel
- **Machining Methods** Finish milling of mould sidewall
- **Insert** AOKT113508PEER-VM
- **Tool** Dc:SSM190-025G2503(L)-AO11
- **Cutting parameters**  $V_c=220\text{m/min}$ ,  $a_p=1.5\text{mm}$ ,  $a_e=0.25\text{mm}$ ,  $f_z=0.36\text{mm/z}$
- **Cutting performance** perpendicularity  $< 0.012$ , satisfy customers' requirement. Successfully replace imported products!



## Side milling - Cylinder block

- **Workpiece** Cylinder block HT250
- **Machining Methods** Side milling of cylinder block
- **Insert** AOKT113508PEER-VM
- **Tool** KH-2603-AOKT11-M12
- **Cutting parameters**  $V_c=285\text{m/min}$ ,  $a_p=0.8\text{mm}$ ,  $a_e=0.15\text{mm}$ ,  $f_z=0.1\text{mm/z}$
- **Cutting performance** perpendicularity  $< 0.008$ , Successfully replace imported products!



## Side milling - Cylinder block

- **Workpiece** Cr15 Quenching(HRC48) Air cooling
- **Machining way** Groove milling
- **Insert** AOKT113508PEER-VM WS5115
- **Tool** SSM190-020G2002-AO11
- **Cutting parameters**  $V_c=138\text{m/min}$ ,  $a_p=0.12\text{mm}$ ,  $a_e=5\text{mm}$ ,  $f_z=0.25\text{mm/z}$
- **Cutting performance** Comparing with cermet insert from BRAND A, the surface quality (burr-free sidewall) and life are comparable.

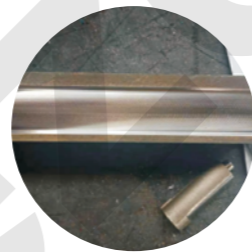

HARDSTONE AOKT tool provide high dimensional precision, sharp edge, light and smooth cutting, excellent surface quality.

## Roughing - Cast iron

- **Workpiece** Dry cut casting steel
- **Machining Methods** Rough milling of cast steel
- **Insert** ZNMU080608PNR-GM/WS5120
- **Tool** CSM390-200C6012-ZN08
- **Cutting parameters**  $N=300/\text{min}$ ,  $a_p=2\sim 5\text{mm}$ ,  $F=700\text{mm/min}$
- **Cutting life** HARDSTONE: 3 hrs, Brand A: 2.5 hrs
- **Cutting performance** Good surface quality, long cutting life, high cost performance



## Mounting surface - Milling plate spring

- **Workpiece** Dry cutting 40CrMo HB285-333 Back of plate spring
- **Machining Methods** Mounting surface of Milling plate spring
- **Insert** SSM390-063A2205-ZN08
- **Tool** ZNMU080608PNR-GM/WS5120
- **Cutting parameters**  $N=720/\text{min}$ ,  $a_p=1.5\sim 3\text{mm}$ ,  $F=540\text{mm/min}$
- **Cutting life** HARDSTONE: 27pieces, Brand A: 12pieces
- **Cutting performance** Good surface quality, long cutting life, high cost performance



## Cases

## Clean-up machining - Frame

- **Workpiece** Frame 45# steel
- **Machining Methods** Clean-up machining of mould frame
- **Insert** ZNMU040308PNR-GM/WS5130
- **Tool** SSM390-021G2002L-ZN04
- **Cutting parameters** N=2750/min,  $ap=0.3\text{mm}$ ,  $ae=0.5\sim 21\text{mm}$ ,  $F=2500\text{mm/min}$
- **Original insert** APMT1135
- **Original cutting parameters** N=2750/min,  $F=2500\text{mm/min}$ ,  $ap=0.3\text{mm}$ ,  $ae=0.5\sim 21\text{mm}$
- **Cutting life** HARDSTONE:3hours(3pieces), Brand A:2hours(2pieces)
- **Cutting performance** Light cutting, cutting efficiency increased by 3 times, long lifespan, good surface quality, remarkable economic benefit.

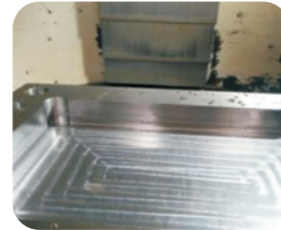

## Roughing - Internal Mould Insert

- **Workpiece** XF136BDHH
- **Machining Methods** Roughing of internal mold insert, dry cutting
- **Insert** ZNMU040308PNR-GM/WS5115
- **Tool** SSM390-021G2002L-ZN04
- **Cutting parameters**  $Vc=132\text{m/min}$ ,  $N=2000/\text{min}$ ,  $ap=0.4\text{mm}$ ,  $ae=15\text{mm}$ ,  $fz=3000\text{mm/r}$
- **Original insert** APMT1135
- **Original cutting parameters**  $Vc=132\text{m/min}$ ,  $N=2000/\text{min}$ ,  $F=2000\text{mm/r}$ ,  $ap=0.25\text{mm}$ ,  $ae=15\text{mm}$
- **Cutting life** HARDSTONE: 40 mins, No obvious wear; Brand A: 30 mins, Cutting edge burst crack
- **Cutting performance** Light cutting, cutting efficiency increased to 240%, good surface quality, long lifespan.



## Forming - Front mold insert

- **Workpiece** JY136ADHH
- **Machining Methods** Contour machining of front mold insert Dry cutting
- **Insert** ZNMU040308PNR-GM/WS5115
- **Tool** SSM390-021G2002L-ZN04
- **Cutting parameters**  $Vc=132\text{m/min}$ ,  $N=2000/\text{min}$ ,  $ap=0.4\text{mm}$ ,  $ae=15\text{mm}$ ,  $F=3000\text{mm/min}$
- **Original insert** APMT1135
- **Original cutting parameters**  $Vc=132\text{m/min}$ ,  $N=2000/\text{min}$ ,  $F=2000\text{mm/min}$ ,  $ap=0.4\text{mm}$ ,  $ae=15\text{mm}$
- **Cutting life** HARDSTONE:37mins; Brand A:10mins+
- **Cutting performance** Light cutting, cutting efficiency increased to 168%, good surface quality, lifespan increased 3.7 times.

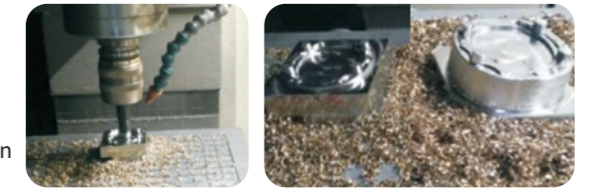

## Finish milling - Stainless Steel Blade

- **Workpiece** Blade, 2Cr11Mo1VNbN
- **Machining Methods** Finish milling of stainless steel blade (air cooling)
- **Insert** RPKT10T3MO-MS WS7130
- **Cutting parameters**  $Vc=235.5\text{m/min}$ ,  $ap=0.8\text{mm}$ ,  $e=2\text{mm}$ ,  $fz=0.42\sim 0.74\text{mm/r}$
- **Cutting performance** Performance comparison after two pieces machining for both HARDSTONE and Brand A

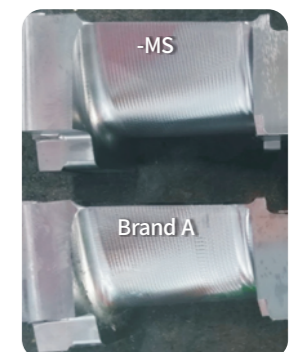

HARDSTONE quality and dimension precision are much better than Brand A

# Hardstone Efficient Cutting tools

